

**ALUREK**  
ALUMINIUM | ARCHITECTURE | BUILDING SYSTEMS

**Seramik Cephe Katalođu**  
Ceramic Facade Catalogue

# ALUREK

ALUMINIUM | ARCHITECTURE | BUILDING SYSTEMS





<b>KLİPSLİ SİSTEM</b> CLIP SYSTEM.....	5
Profiller Profiles.....	6
Detaylar Details.....	9



<b>YAPIŞTIRMALI SİSTEM</b> ADHESIVE SYSTEM.....	13
Profiller Profiles.....	14
Detaylar Details.....	17



<b>SINTERFLEX SİSTEM</b> SINTERFLEX SYSTEM.....	21
Profiller Profiles.....	22
Detaylar Details.....	25



<b>TERRACOTTA SİSTEM</b> TERRACOTTA SYSTEM.....	29
Profiller Profiles.....	30
Detaylar Details.....	33



<b>ZİKOV KANALLI SİSTEM</b> ZIKOV SYSTEM.....	37
Profiller Profiles.....	38
Detaylar Details.....	41



<b>KOMPAKT LAMİNANT SİSTEM</b> COMPACT LAMINATE SYSTEM.....	45
Profiller Profiles.....	46
Detaylar Details.....	49



<b>ASKILI SİSTEM</b> SUSPENDED SYSTEM.....	53
Profiller Profiles.....	54
Detaylar Details.....	57



<b>POLİÜRETAN ASKILI SİSTEM</b> POLYURETHANE SUSPENDED SYSTEM.....	61
Profiller Profiles.....	62
Detaylar Details.....	65



<b>BRAKET LİSTESİ</b> BRACKET LIST.....	69
---	----



<b>STANDART PROFİLLER</b> STANDARD PROFILES.....	71
--	----





**KLİPSLİ SİSTEM**  
CLIP SYSTEM

**ALUREK**  
ALUMINIUM | ARCHITECTURE | BUILDING SYSTEMS

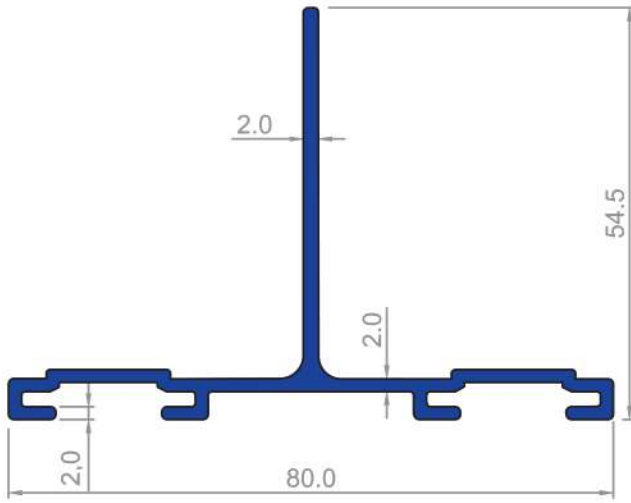

**1601**  
0,905  
Kg/m

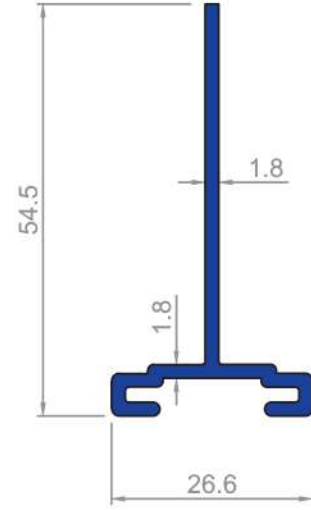

**1603**  
0,452  
Kg/m

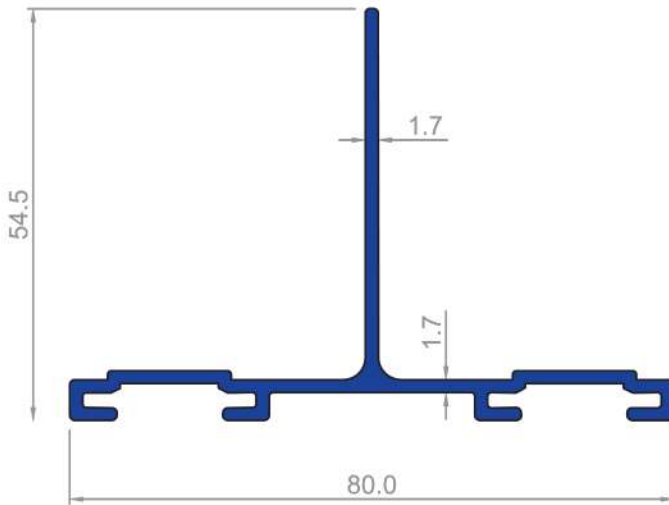

**1616**  
0,771  
Kg/m

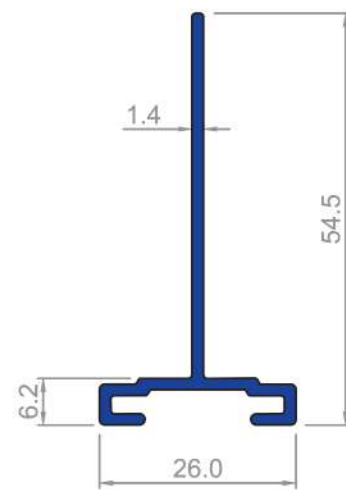

**1618**  
0,350  
Kg/m

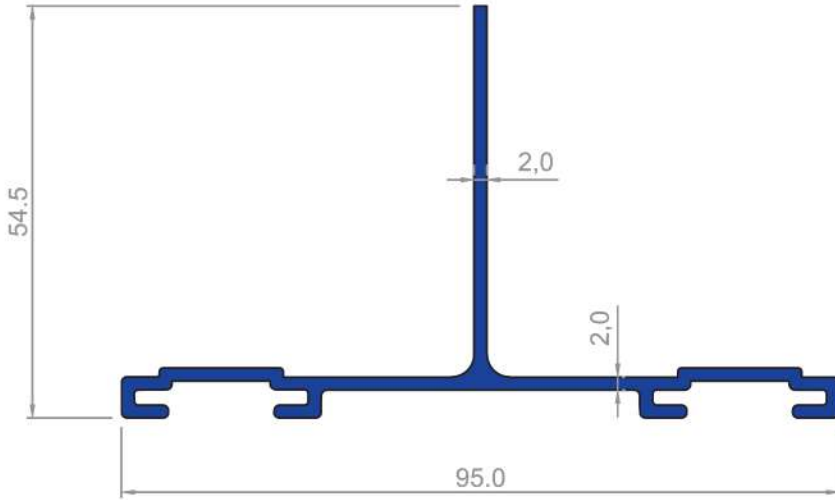

**1602**  
0,995  
Kg/m

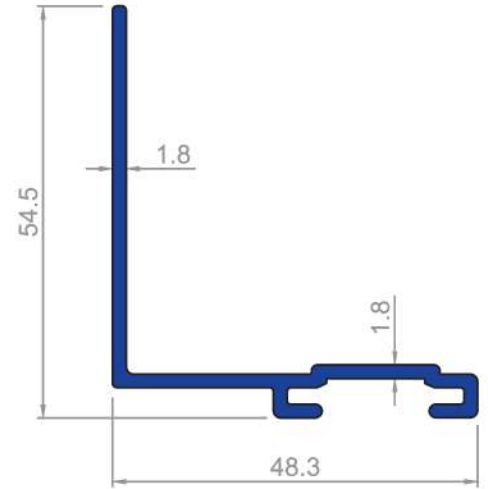

**1604**  
0,565  
Kg/m

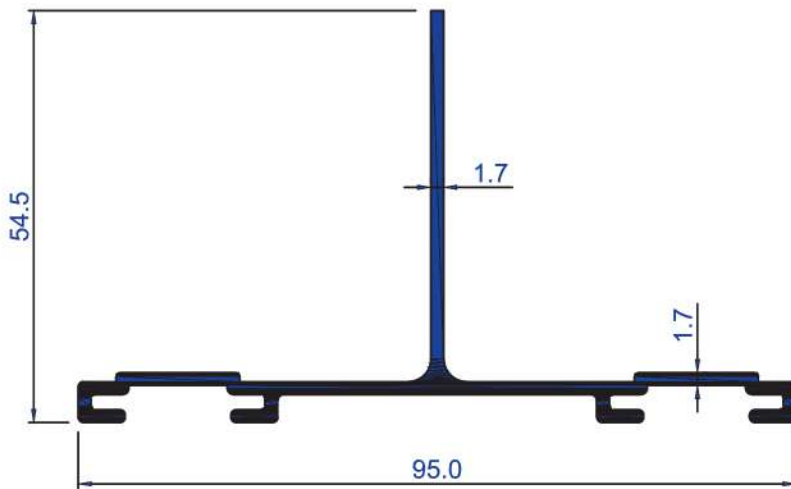

**1617**  
0,843  
Kg/m

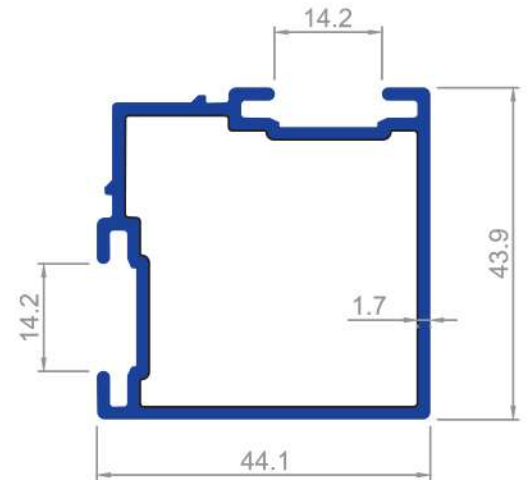

**1609**  
0,875  
Kg/m

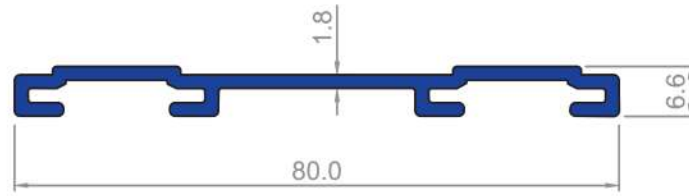
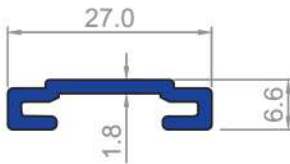
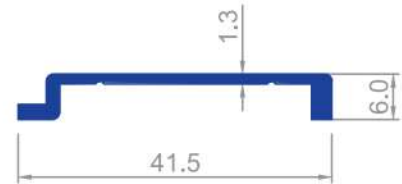
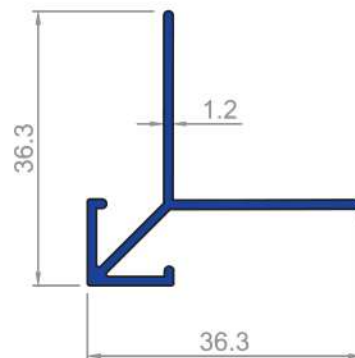
**1639**0,566  
Kg/m**1640**0,220  
Kg/m**1615**0,208  
Kg/m**1610**0,285  
Kg/m



## DETAYLAR DETAILS

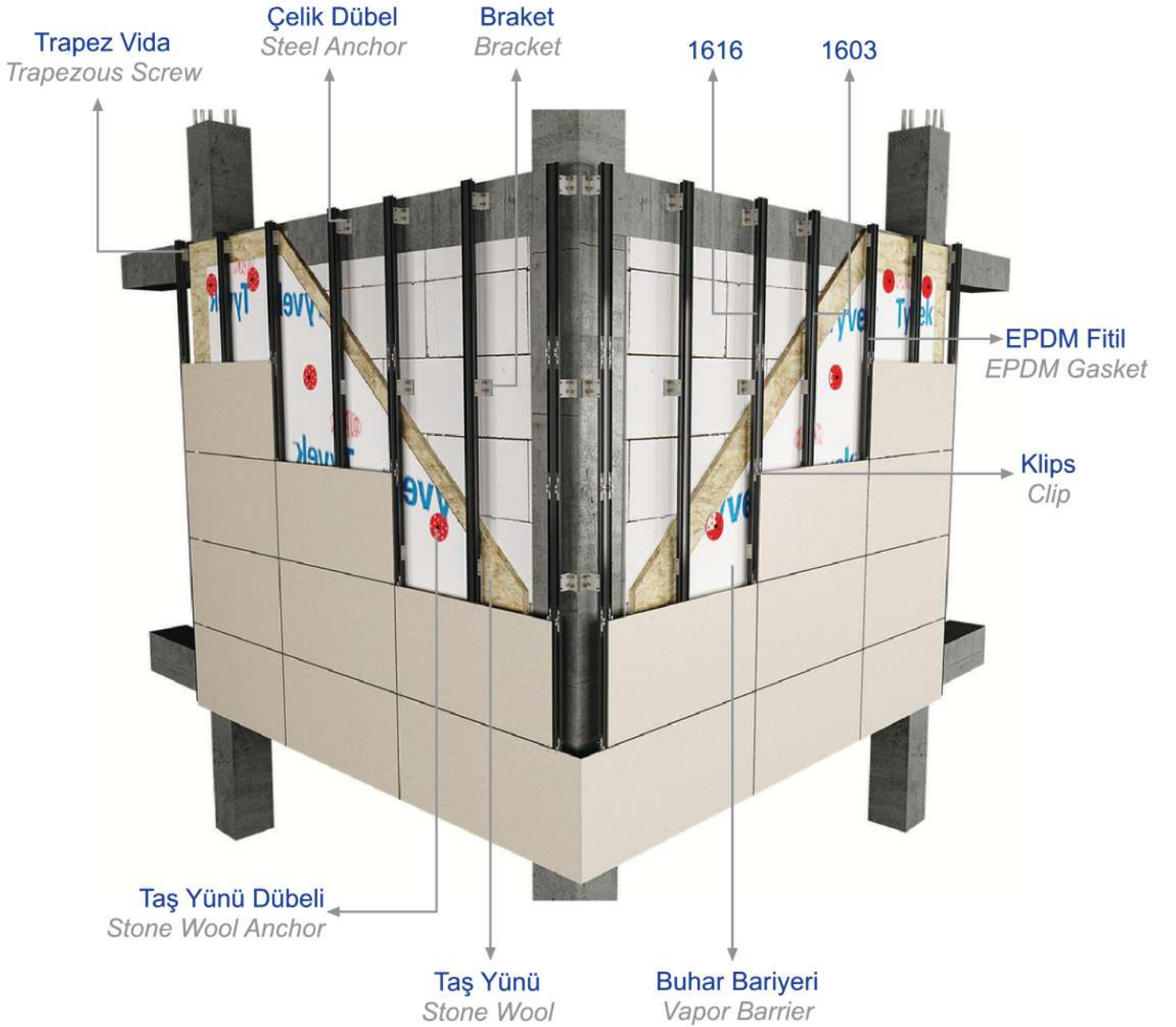

## DETAYLAR DETAILS

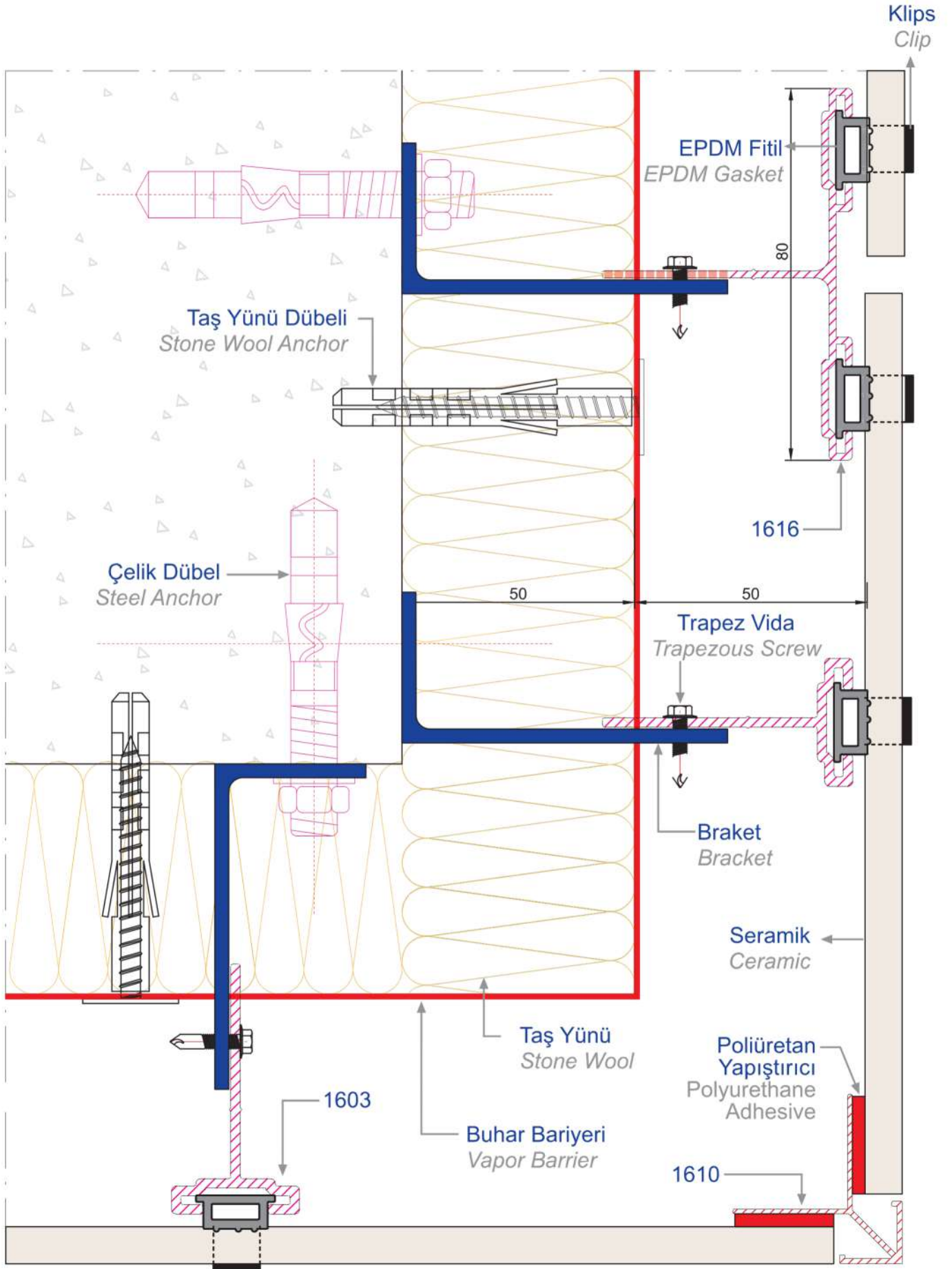

## DETAYLAR DETAILS

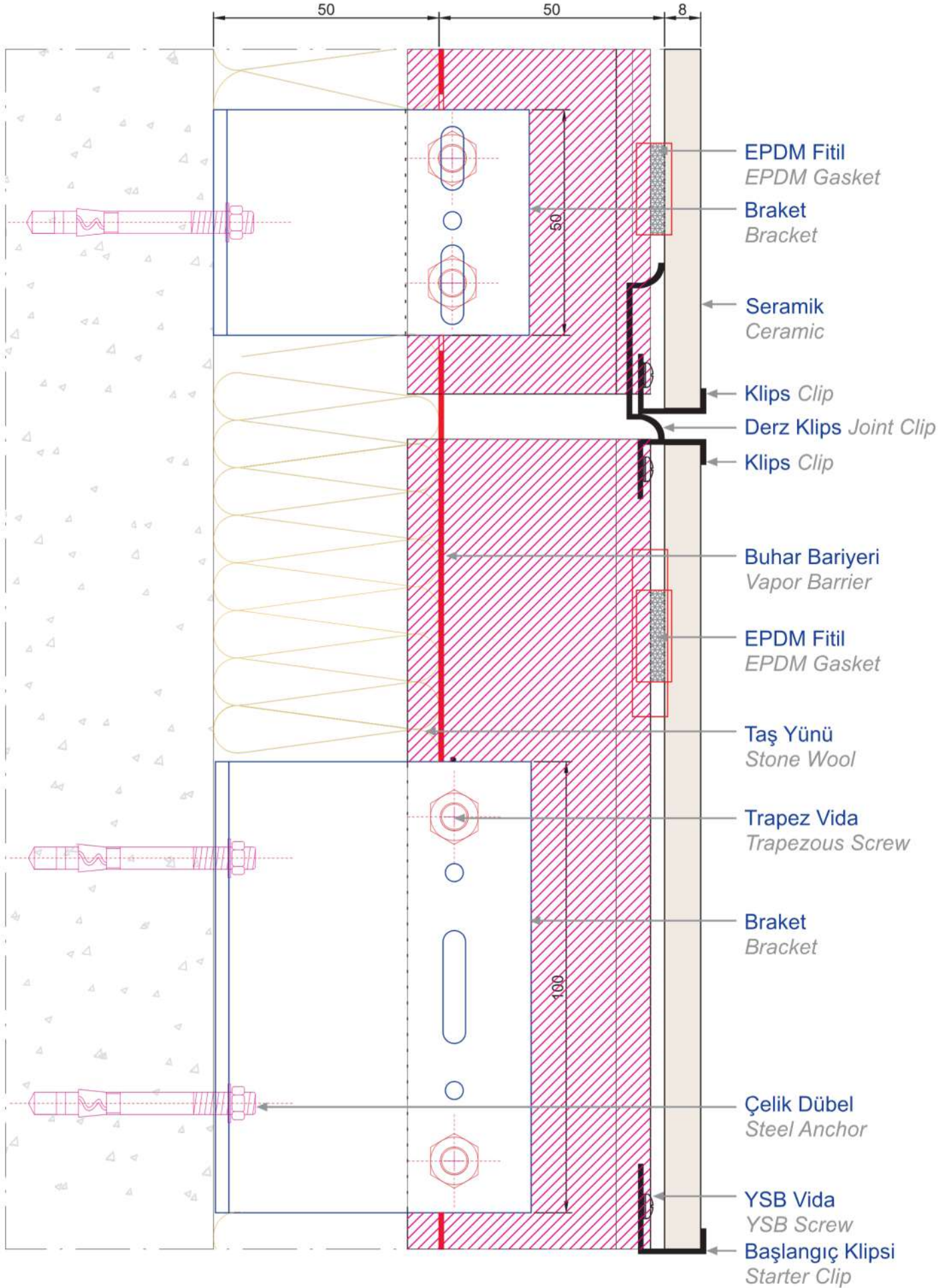

## YARDIMCI MALZEMELER AUXILIARY MATERIALS

Çelik Dübel *Steel Anchor*Taş Yünü *Stone Wool*Trapez Vida *Trapezous Screw*Taş Yünü Dübeli *Stone Wool Anchor*Braket *Bracket*EPDM Fitol *EPDM Gasket*Buhar Bariyeri *Vapor Barrier*Derz Klips *Joint Clip*Başlangıç Klipsi *Starter Clip*Klips *Clip*4'lü Klips *4 Clip-on*2'li Dikey Klips  
*2 Vertical Clip-on*2'li Yatay Klips  
*2 Horizontal Clip-on*



## YAPIŞTIRMALI SİSTEM ADHESIVE SYSTEM

**ALUREK**  
ALUMINIUM | ARCHITECTURE | BUILDING SYSTEMS

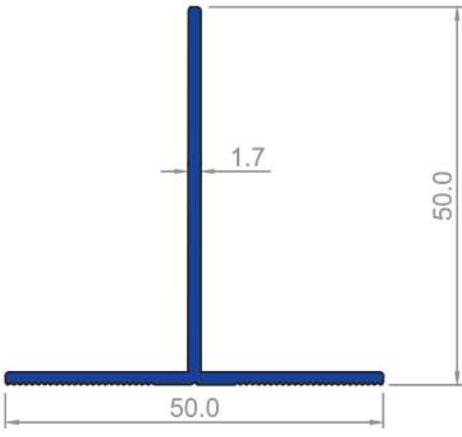
**1621**

0,439

Kg/m

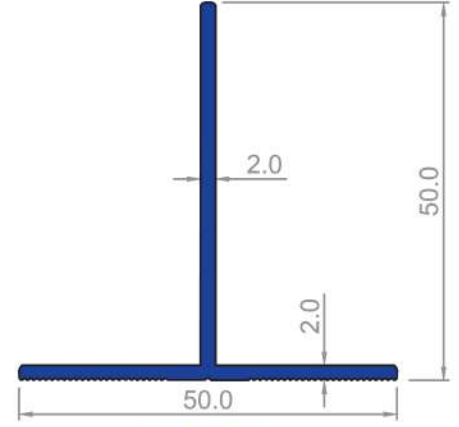
**1622**

0,518

Kg/m

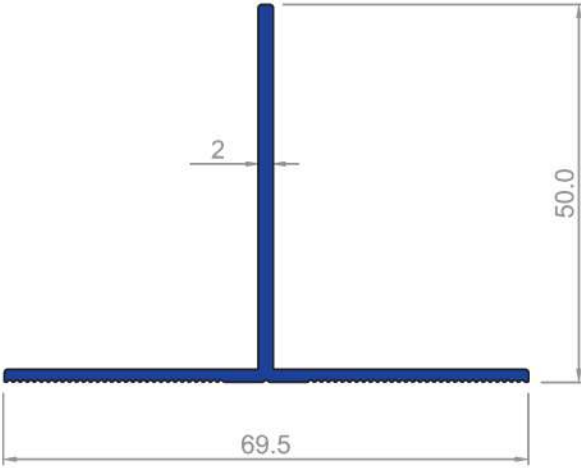
**1626**

0,618

Kg/m

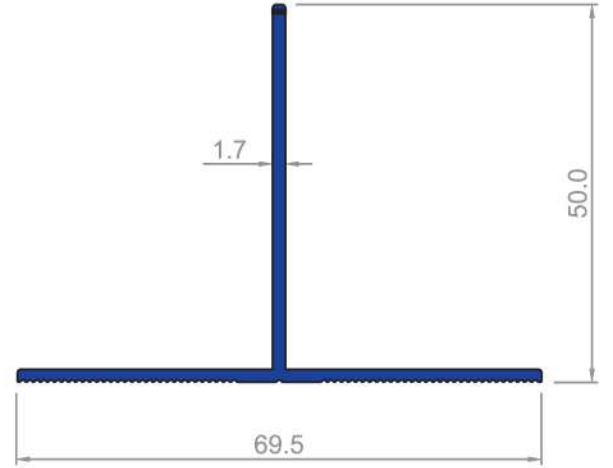
**1600**

0,523

Kg/m

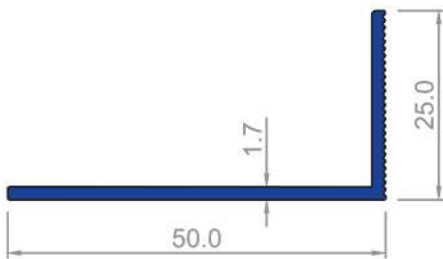
**1608**

0,328

Kg/m

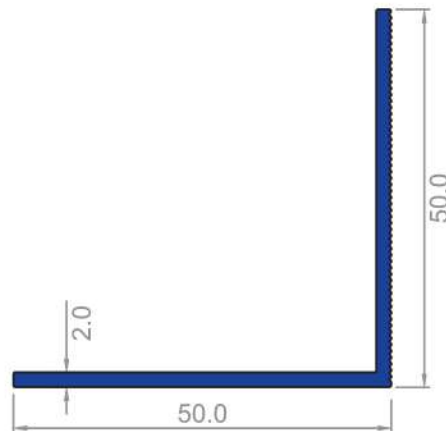
**1641**

0,516

Kg/m

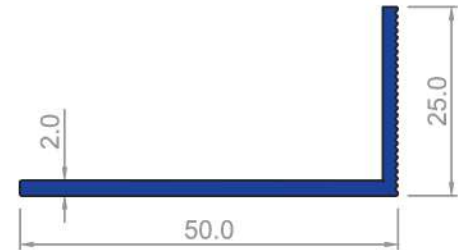
**1642**

0,388

Kg/m

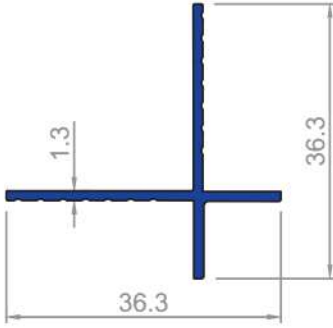

**1643**  
0,246  
Kg/m

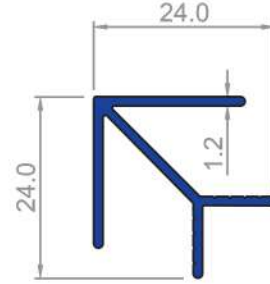

**1613**  
0,246  
Kg/m

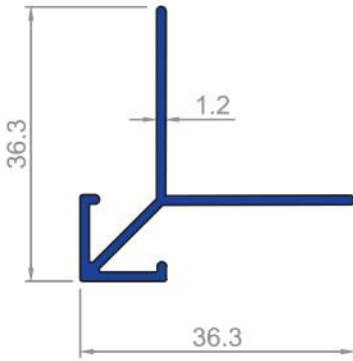

**1610**  
0,285  
Kg/m

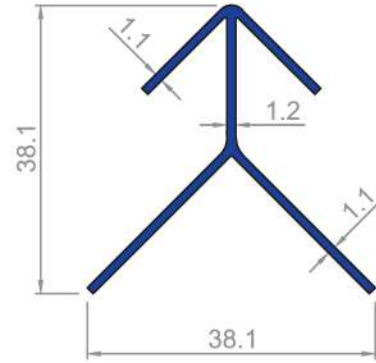

**1644**  
0,309  
Kg/m

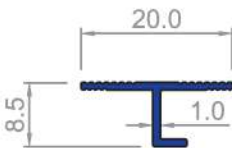

**1606**  
0,080  
Kg/m

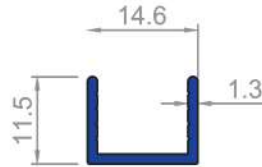

**1614**  
0,121  
Kg/m

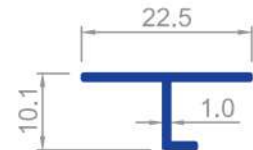

**1607**  
0,095  
Kg/m





## DETAYLAR DETAILS

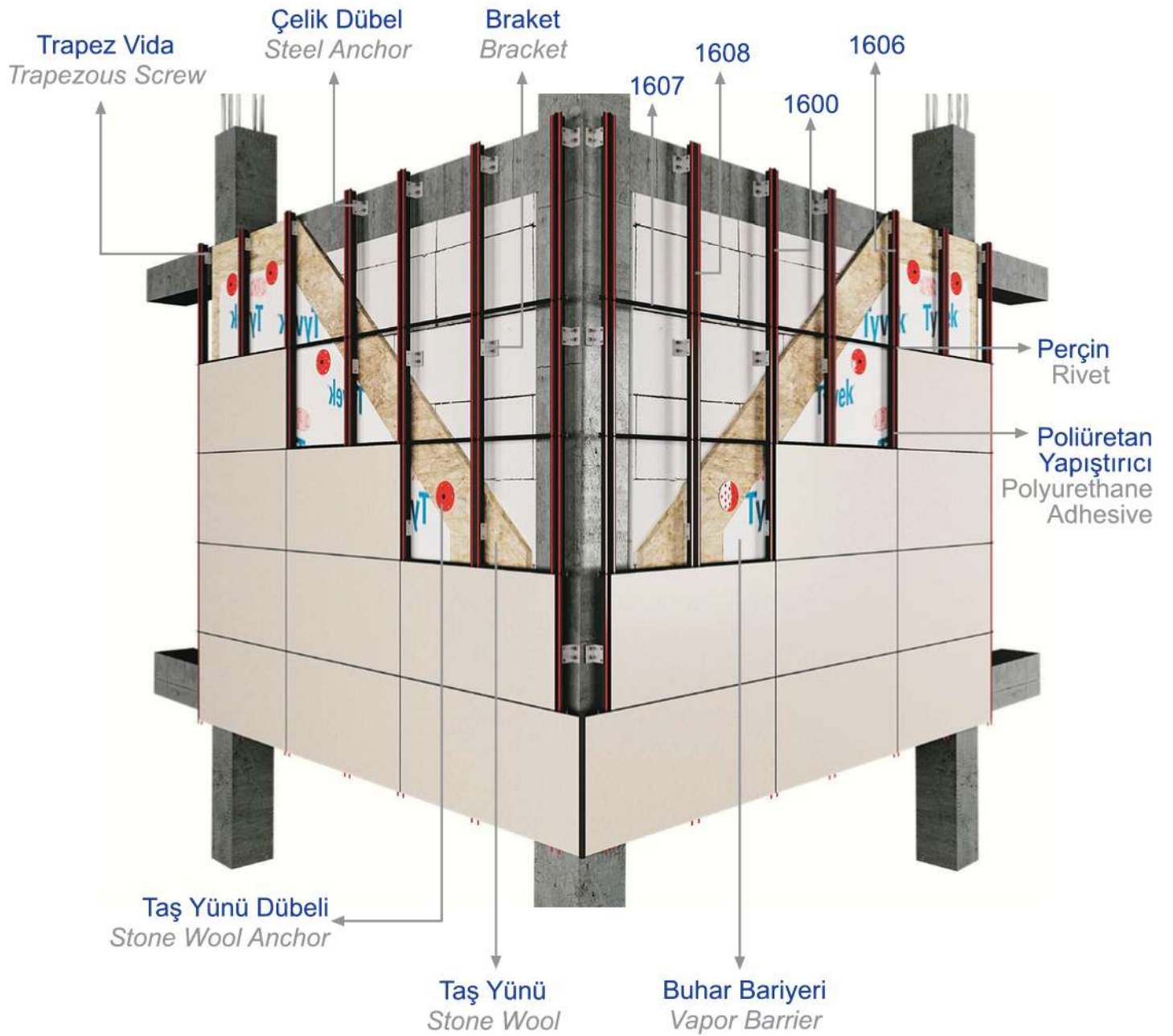
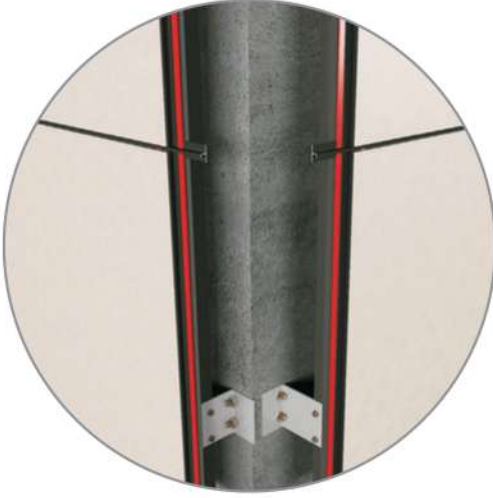

## DETAYLAR DETAILS

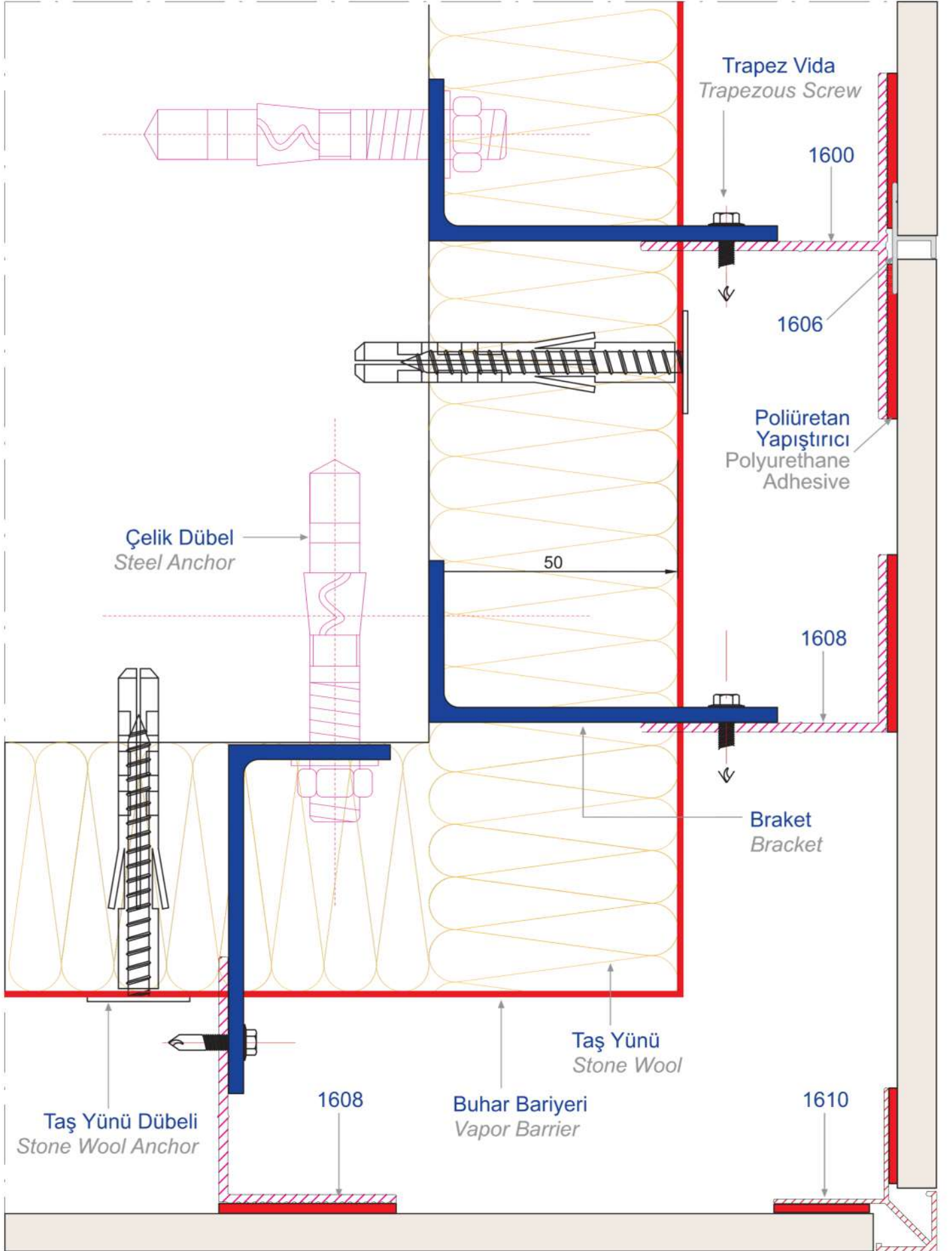

## DETAYLAR DETAILS

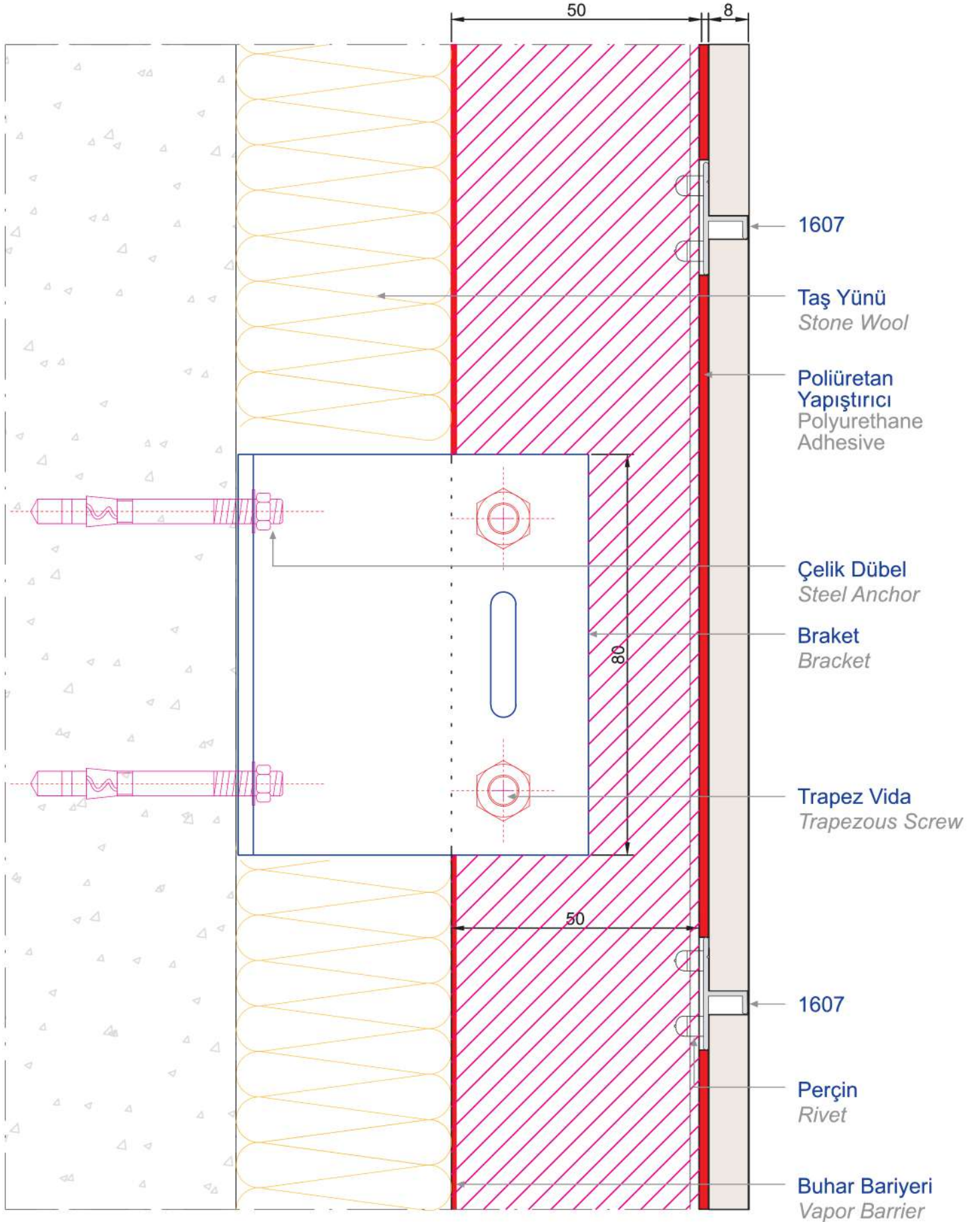

## YARDIMCI MALZEMELER AUXILIARY MATERIALS

Çelik Dübel *Steel Anchor*Taş Yünü *Stone Wool*Trapez Vida *Trapezous Screw*Taş Yünü Dübeli *Stone Wool Anchor*Braket *Bracket*Perçin *Rivet*Buhar Bariyeri *Vapor Barrier*Soudal 40FC *Soudal 40FC*



## SINTERFLEX SİSTEM SINTERFLEX SYSTEM

**ALUREK**  
ALUMINIUM | ARCHITECTURE | BUILDING SYSTEMS

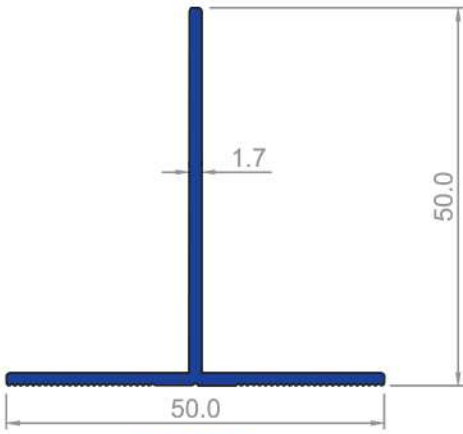

**1621**  
0,439  
Kg/m

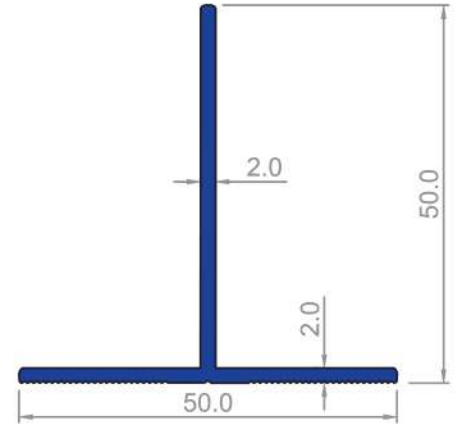

**1622**  
0,518  
Kg/m

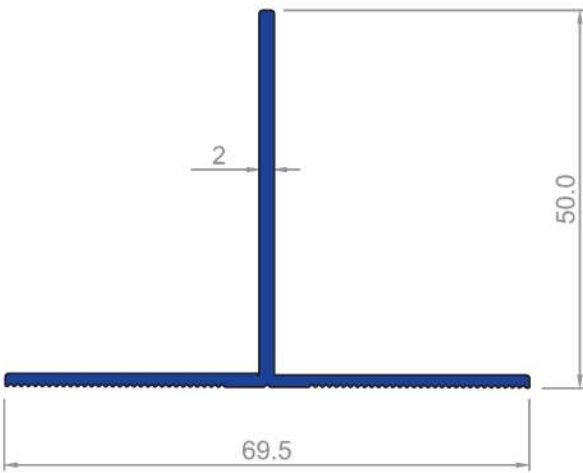

**1626**  
0,618  
Kg/m

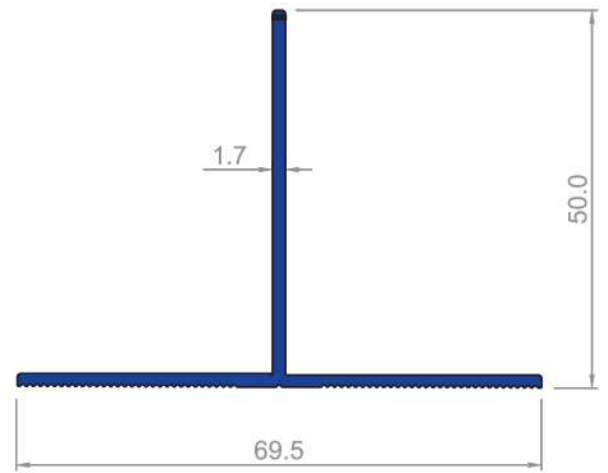

**1600**  
0,523  
Kg/m

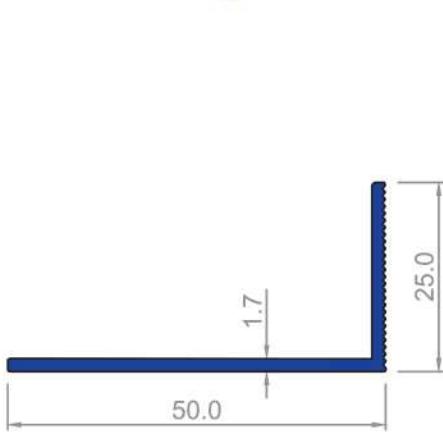

**1608**  
0,328  
Kg/m

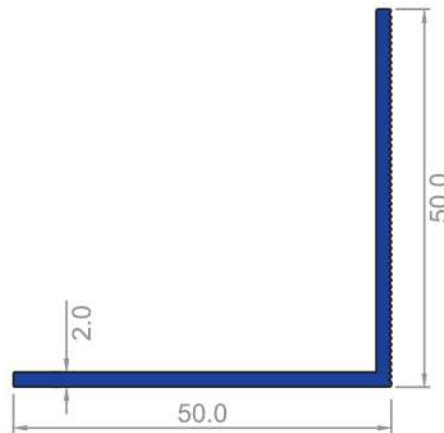

**1641**  
0,516  
Kg/m

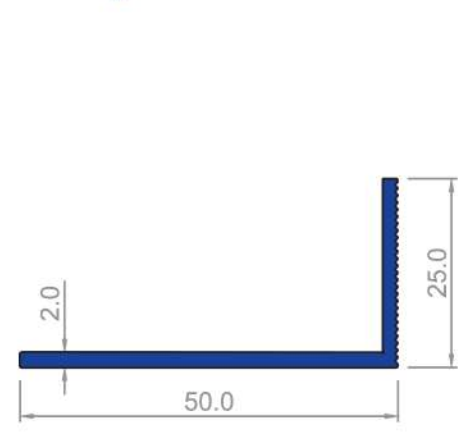

**1642**  
0,388  
Kg/m

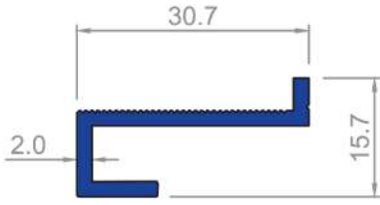

**1651**  
0,279  
Kg/m

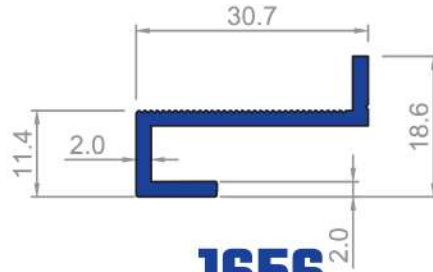

**1656**  
0,295  
Kg/m

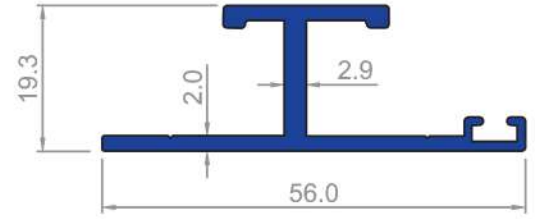

**1654**  
0,567  
Kg/m

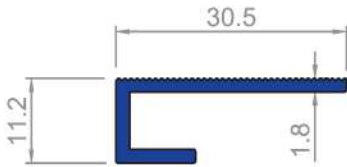

**1652**  
0,265  
Kg/m

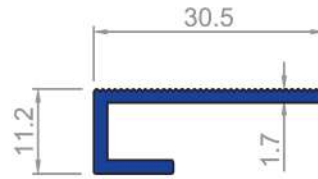

**1655**  
0,215  
Kg/m

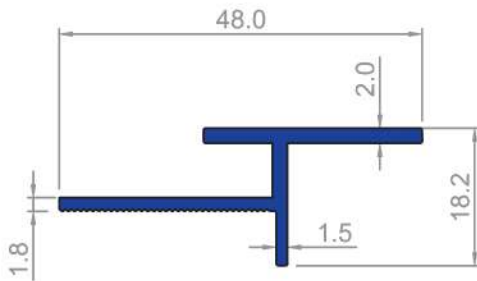

**1657**  
0,370  
Kg/m

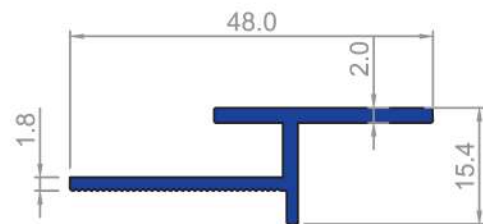

**1653**  
0,352  
Kg/m

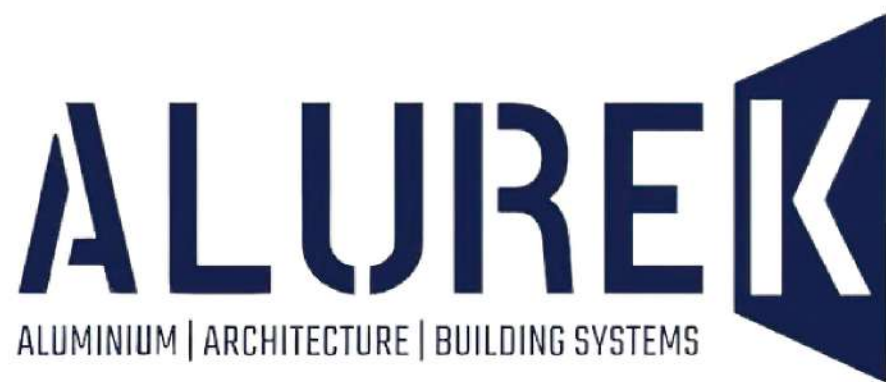



## DETAYLAR DETAILS

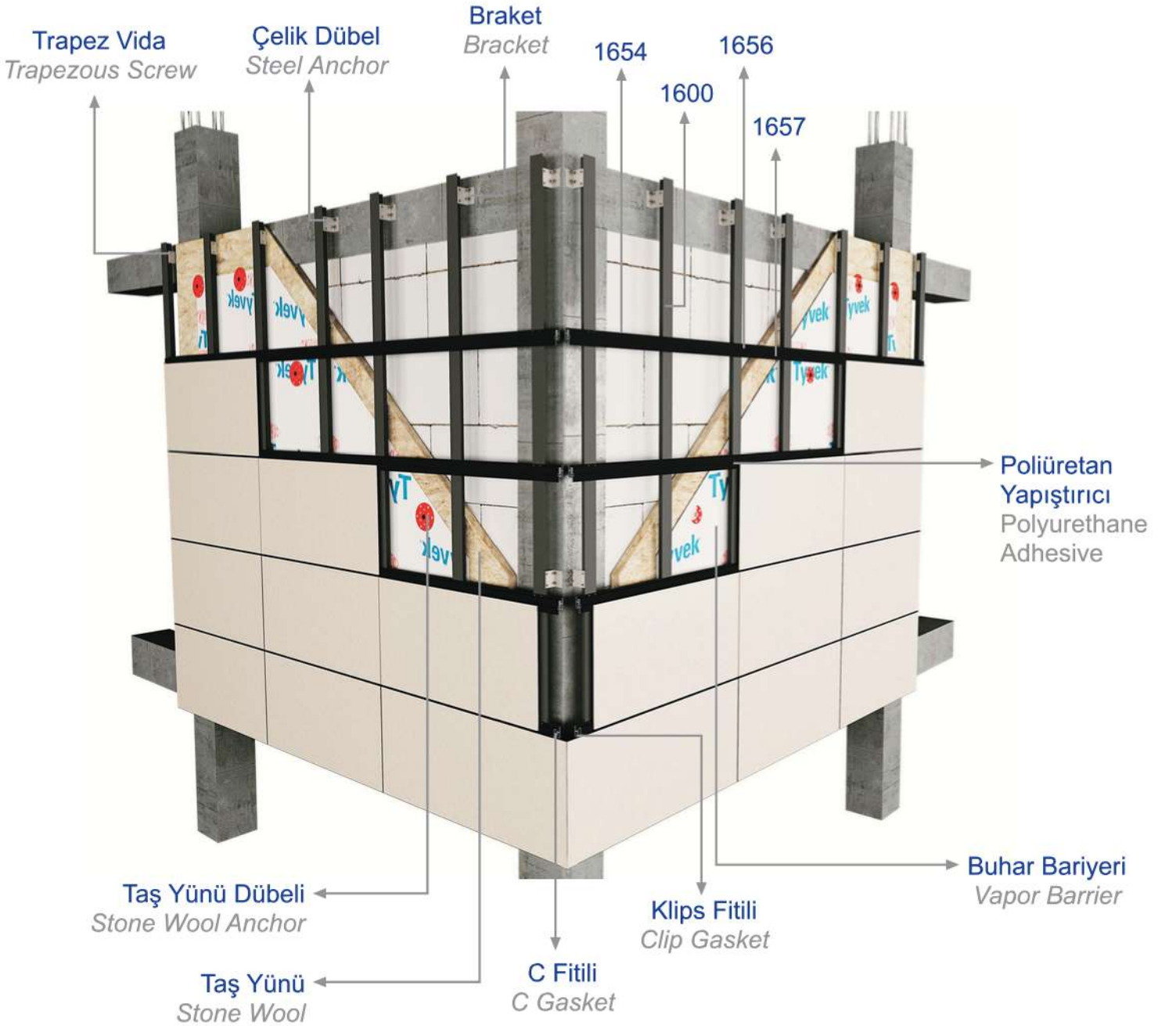

## DETAYLAR DETAILS

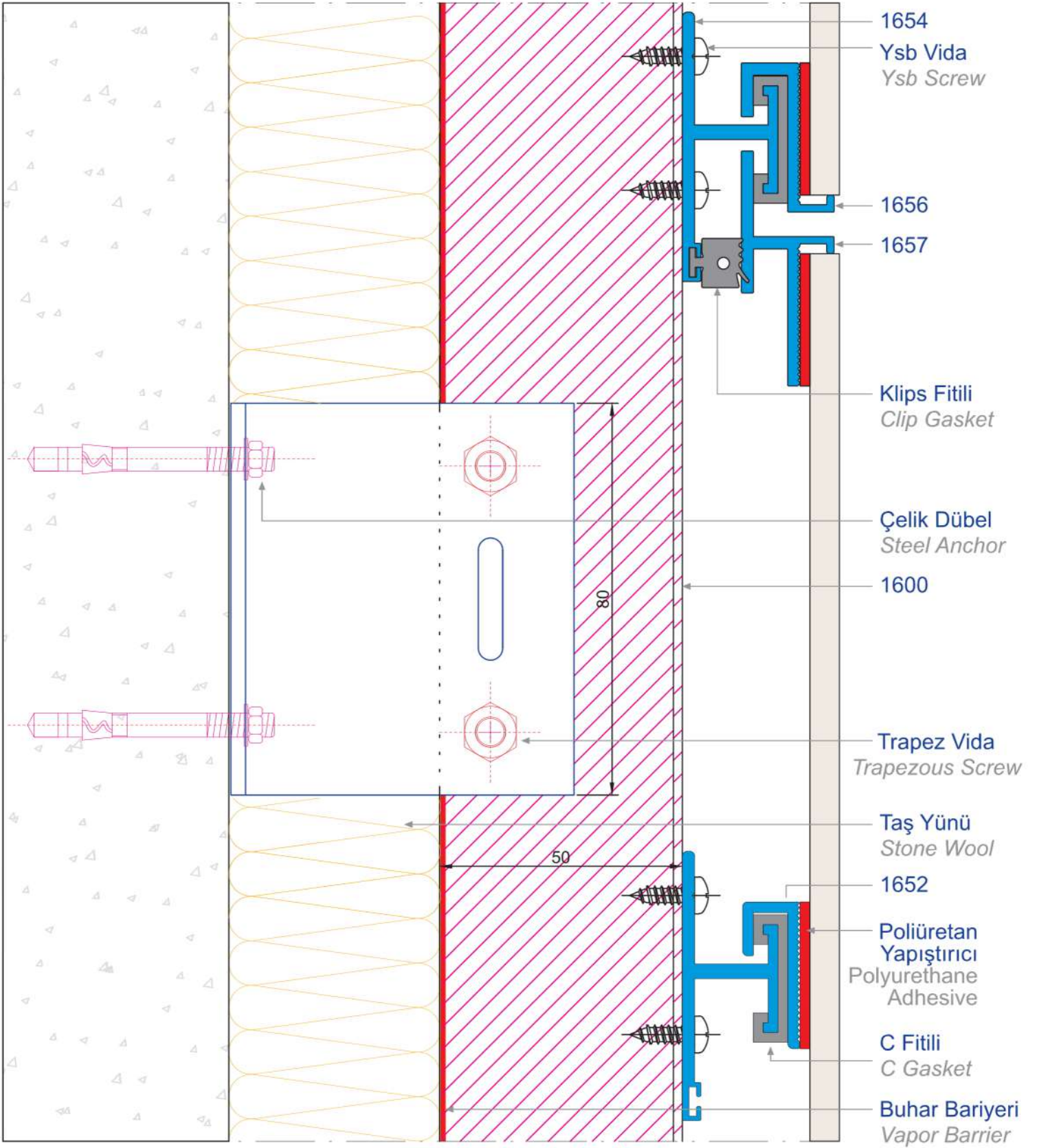



## YARDIMCI MALZEMELER AUXILIARY MATERIALS

Çelik Dübel *Steel Anchor*Taş Yünü *Stone Wool*Trapez Vida *Trapezous Screw*Taş Yünü Dübeli *Stone Wool Anchor*Braket *Bracket*Perçin *Rivet*Buhar Bariyeri *Vapor Barrier*Soudal 40FC *Soudal 40FC*Klips Fitili *Clip Gasket*C Fitil *C Gasket*



## TERRACOTTA SİSTEM TERRACOTTA SYSTEM

**ALUREK**  
ALUMINIUM | ARCHITECTURE | BUILDING SYSTEMS

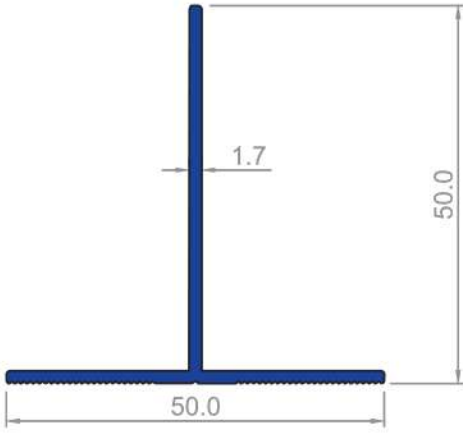

**1621**  
0,439  
Kg/m

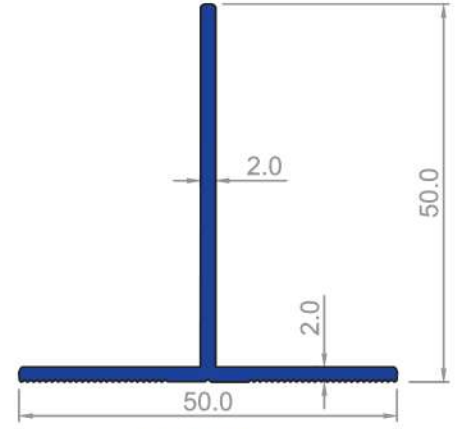

**1622**  
0,518  
Kg/m

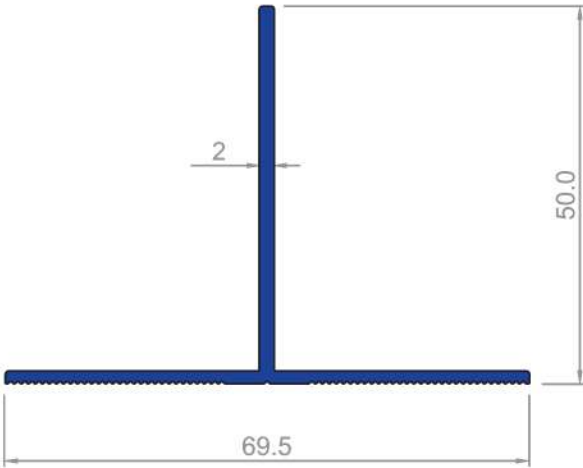

**1626**  
0,618  
Kg/m

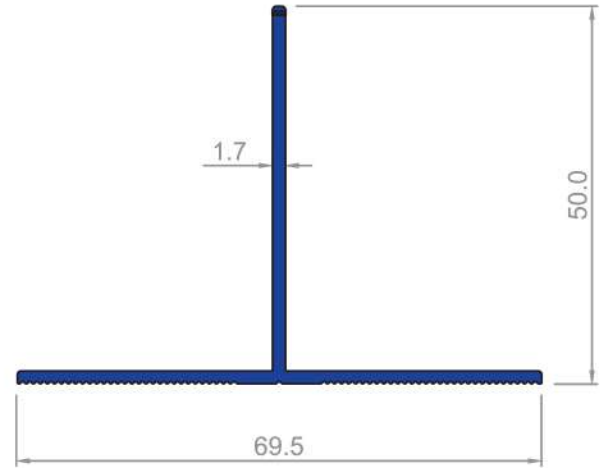

**1600**  
0,523  
Kg/m

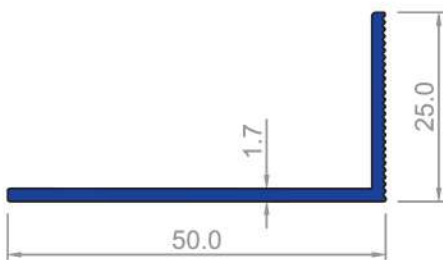

**1608**  
0,328  
Kg/m

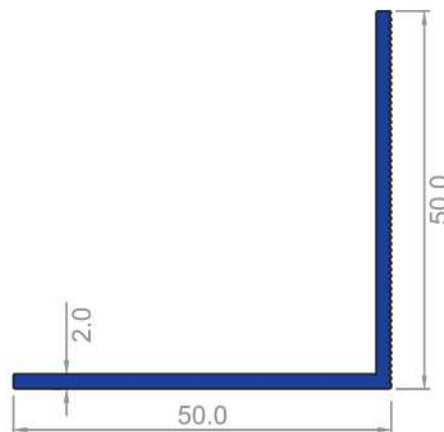

**1641**  
0,516  
Kg/m

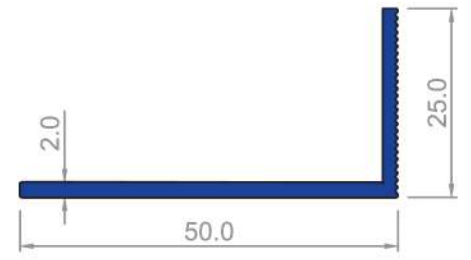

**1642**  
0,388  
Kg/m

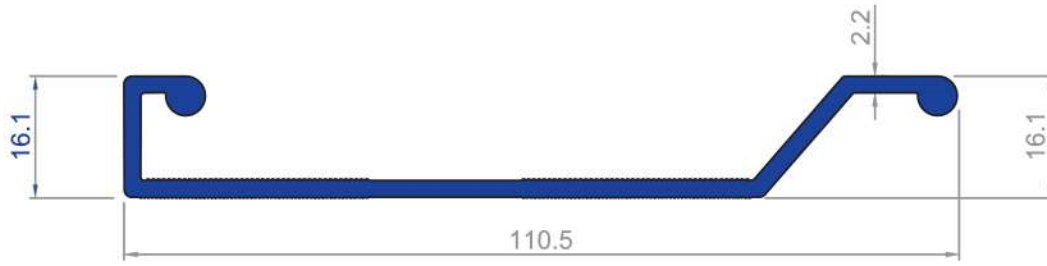

**1611**  
0,919  
Kg/m

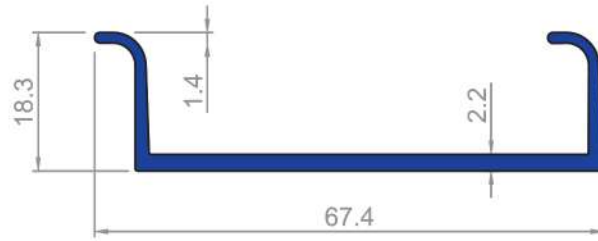

**4356**  
0,535  
Kg/m

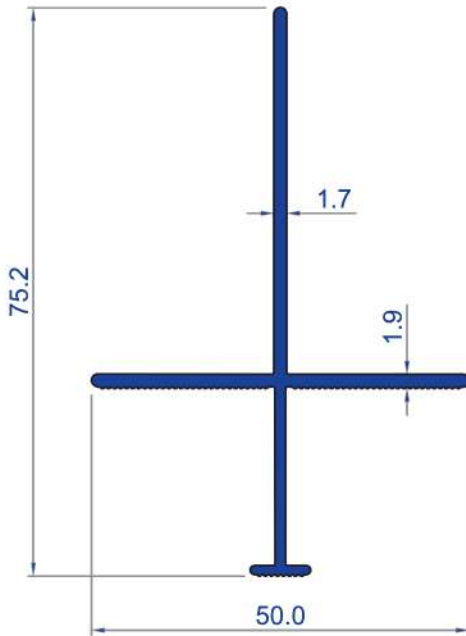

**4357**  
0,581  
Kg/m

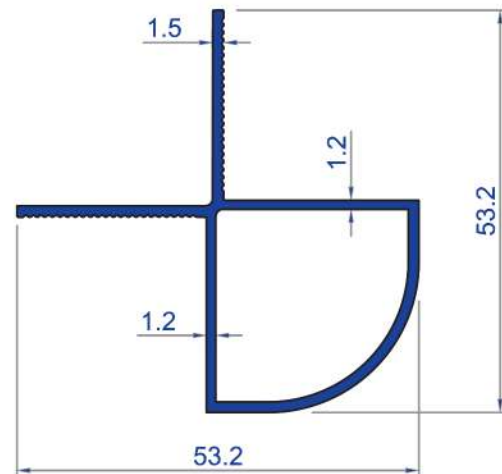

**1612**  
0,525  
Kg/m

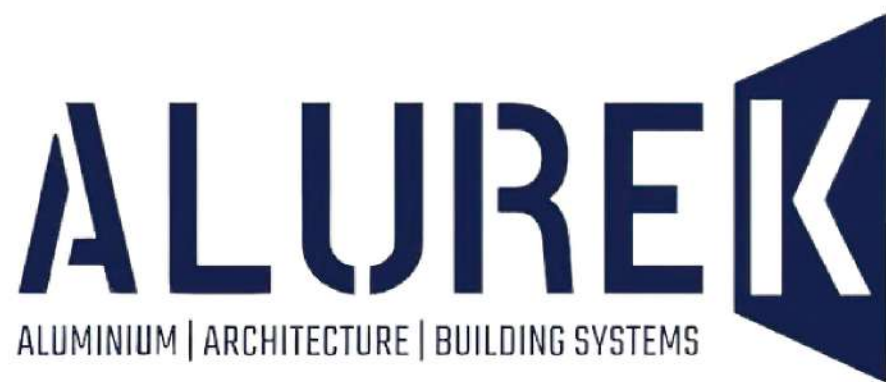



## DETAYLAR DETAILS

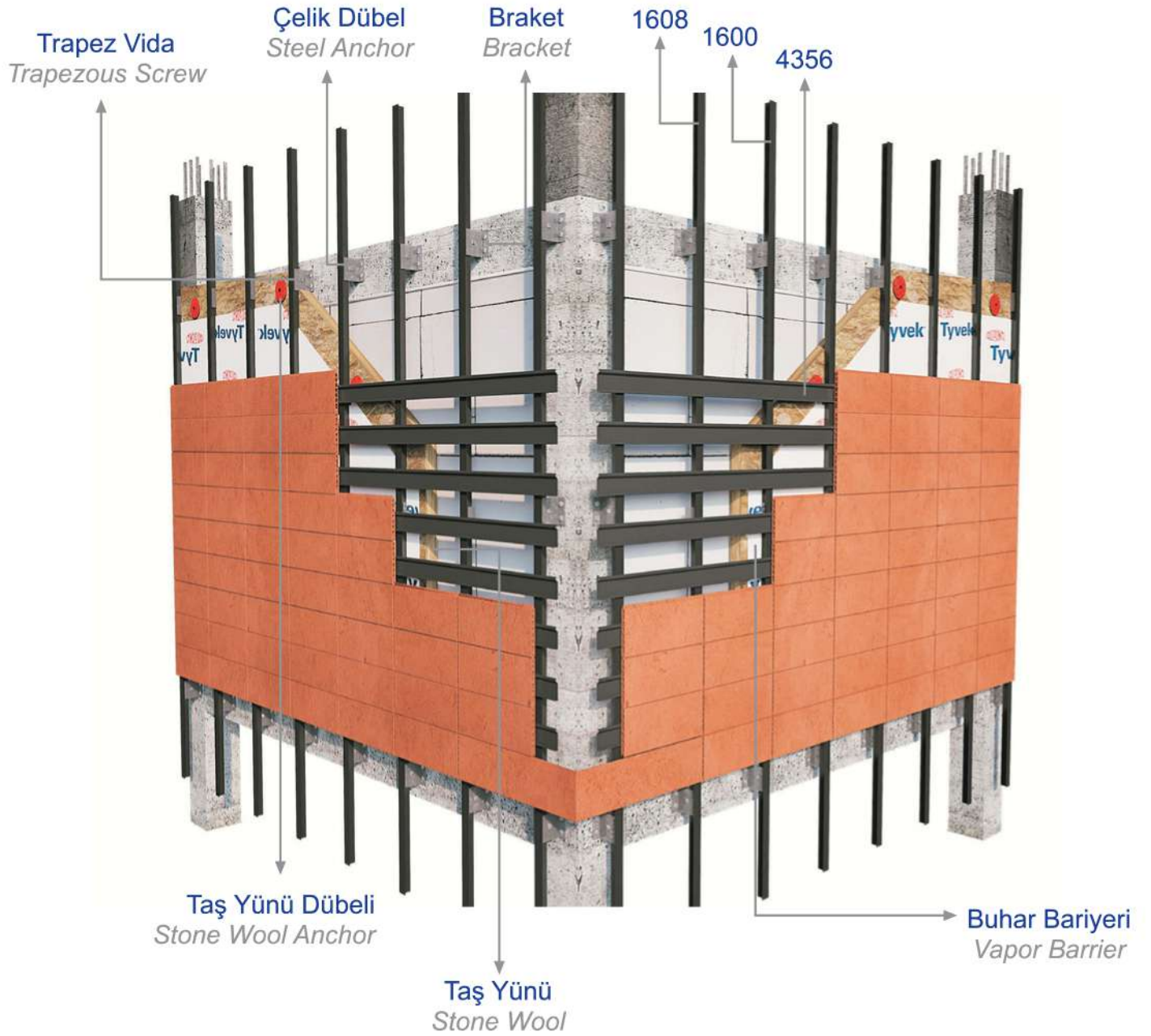
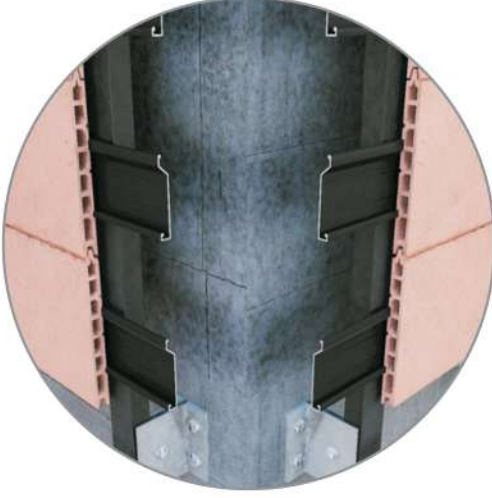

## DETAYLAR DETAILS

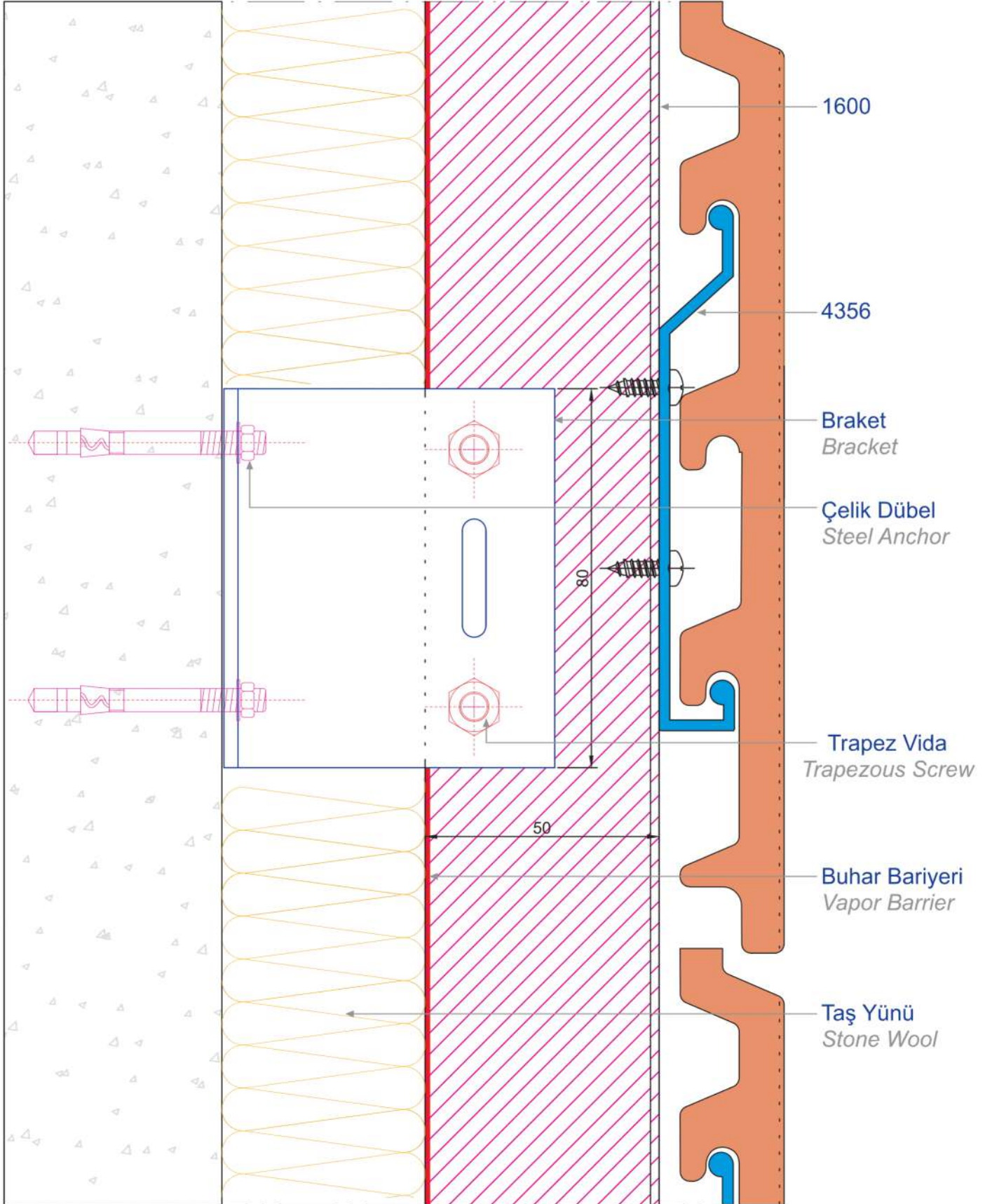

## DETAYLAR DETAILS

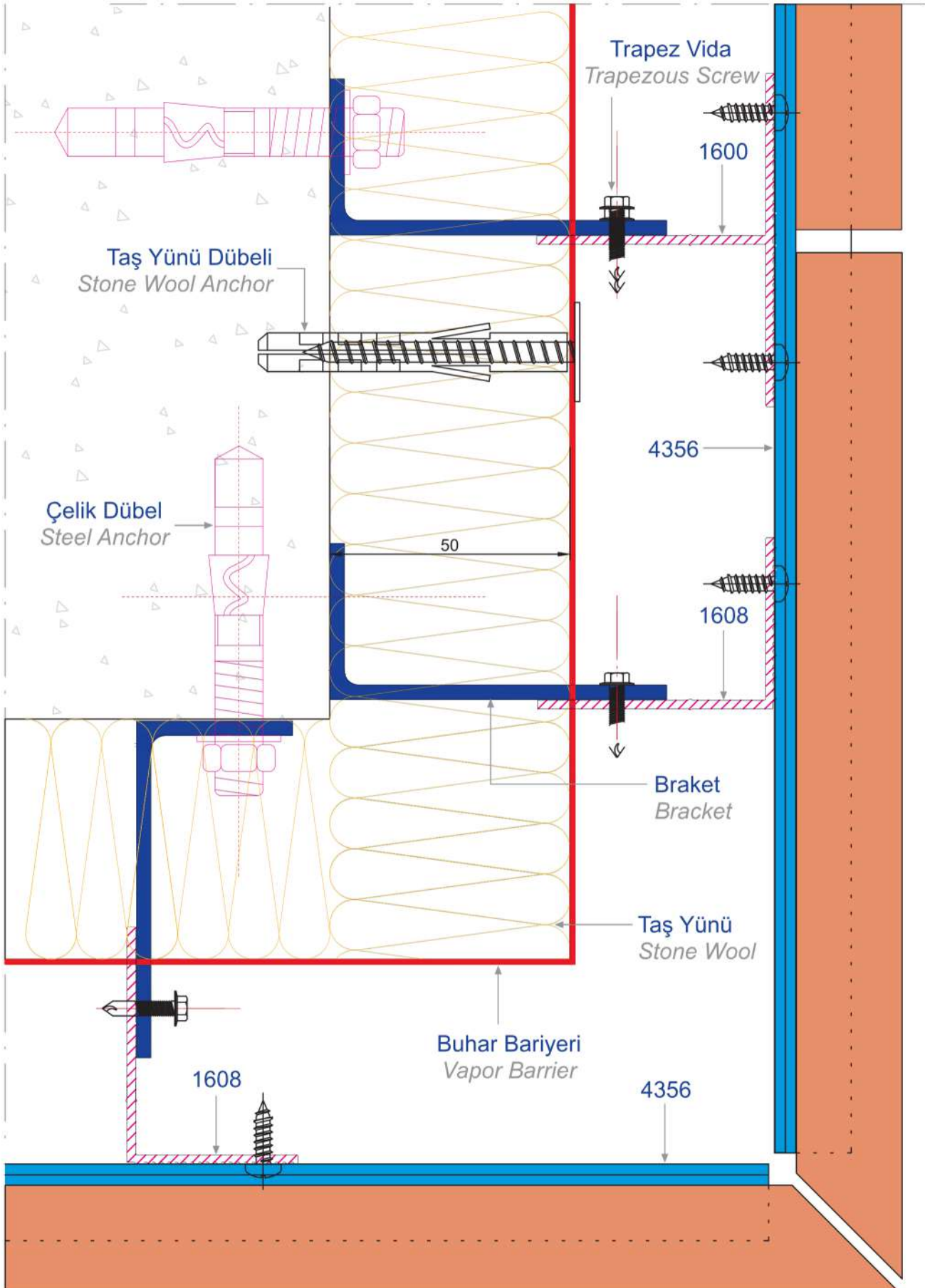

## YARDIMCI MALZEMELER AUXILIARY MATERIALS

Çelik Dübel *Steel Anchor*Taş Yünü *Stone Wool*Trapez Vida *Trapezous Screw*Taş Yünü Dübeli *Stone Wool Anchor*Braket *Bracket*Buhar Bariyeri *Vapor Barrier*



## ZIKOV KANALLI SİSTEM ZIKOV SYSTEM

**ALUREK**  
ALUMINIUM | ARCHITECTURE | BUILDING SYSTEMS

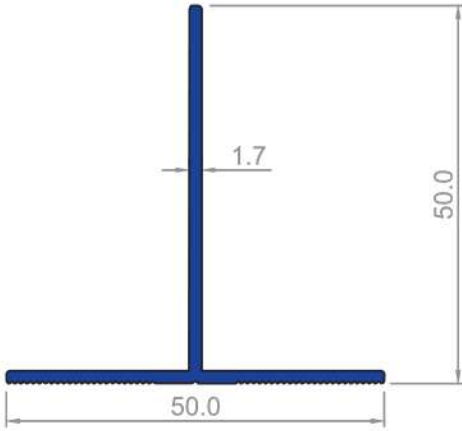

**1621**  
0,439  
Kg/m

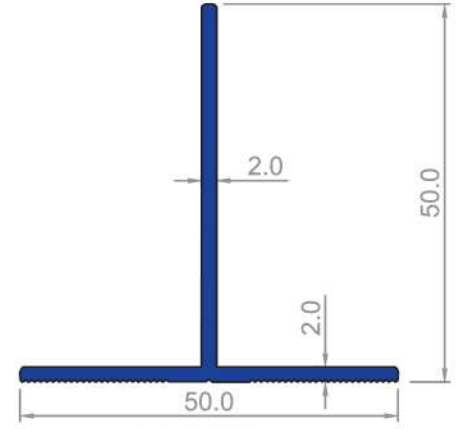

**1622**  
0,518  
Kg/m

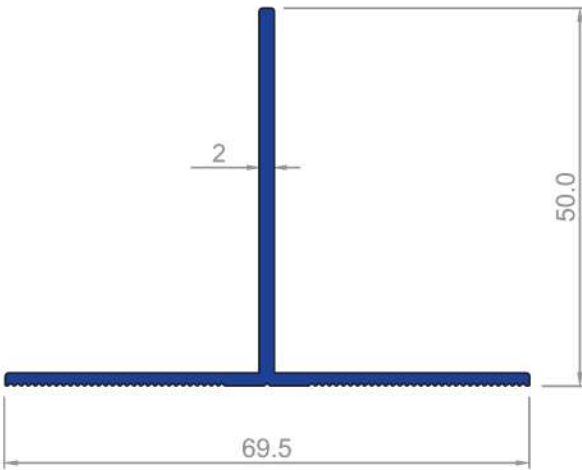

**1626**  
0,618  
Kg/m

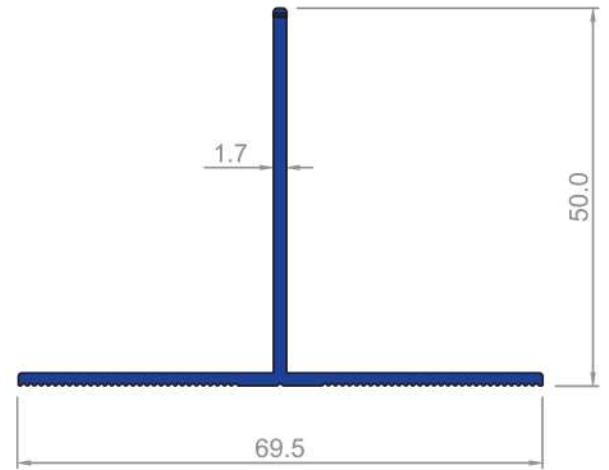

**1600**  
0,523  
Kg/m

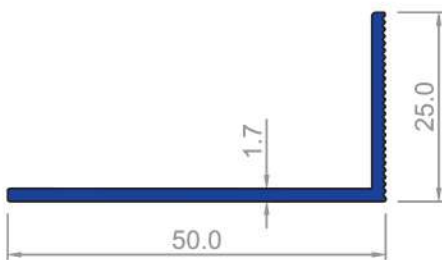

**1608**  
0,328  
Kg/m

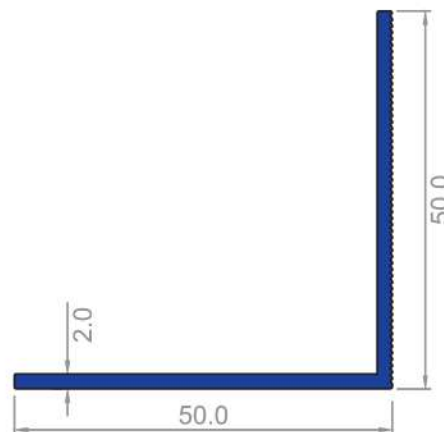

**1641**  
0,516  
Kg/m

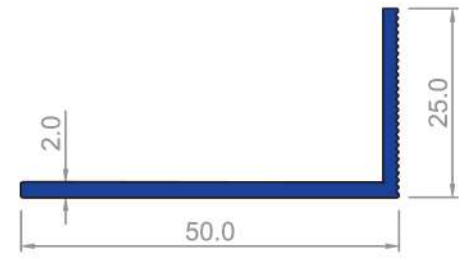

**1642**  
0,388  
Kg/m

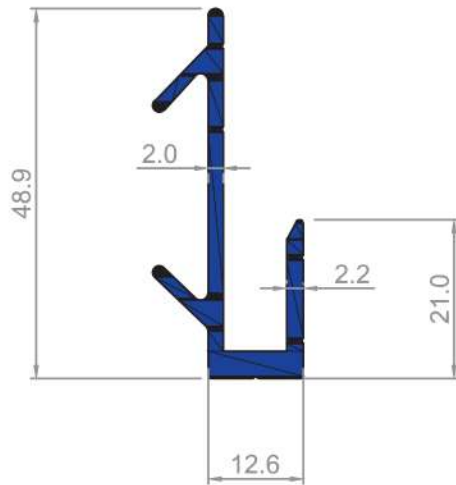
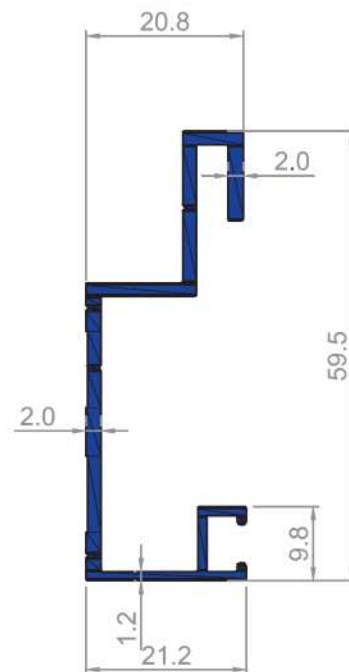
**1682**0,560  
Kg/m**1683**0,560  
Kg/m





## DETAYLAR DETAILS

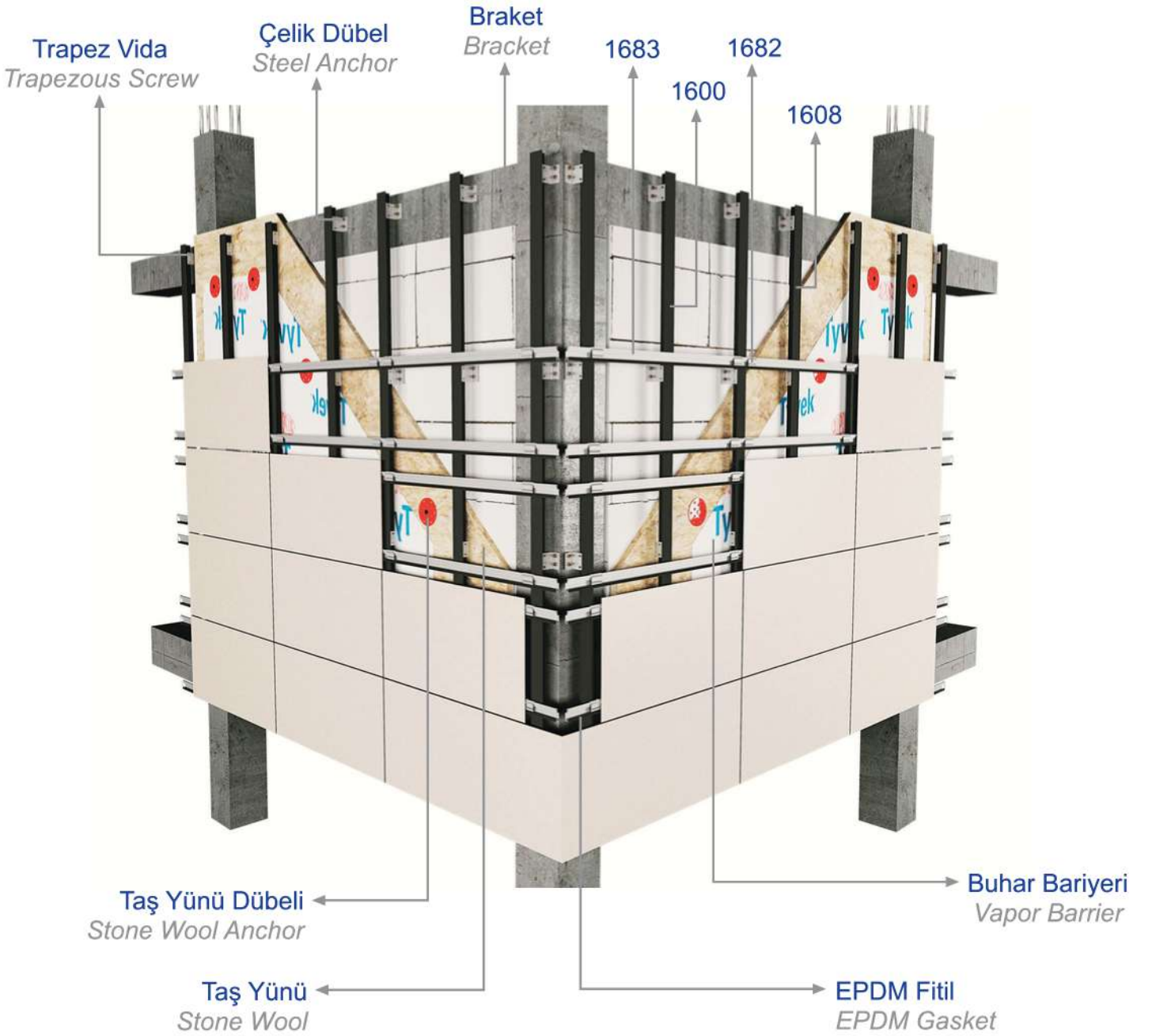
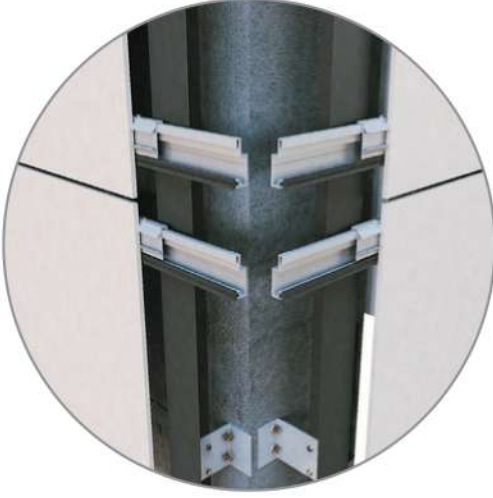

## DETAYLAR DETAILS

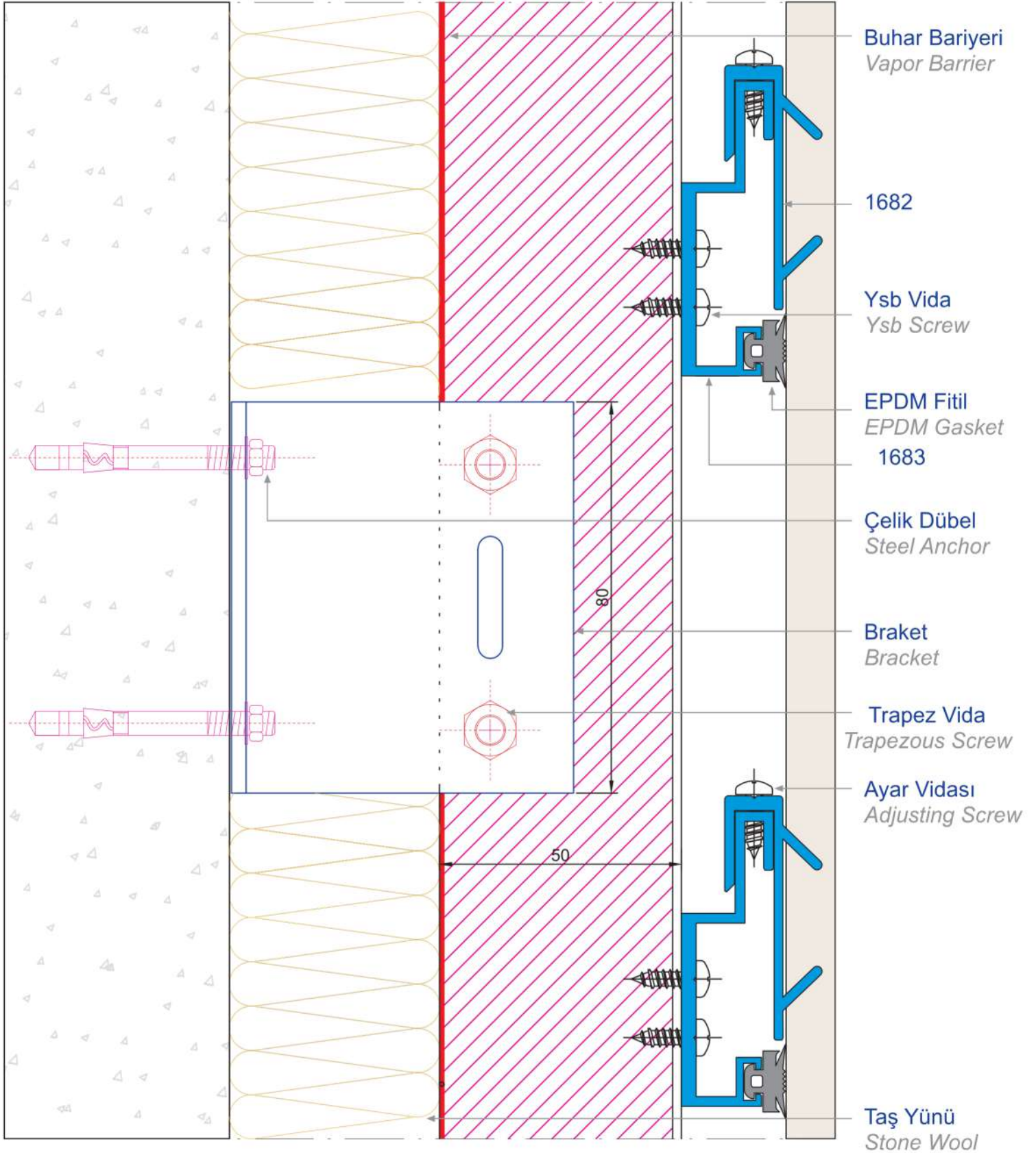

## DETAYLAR DETAILS

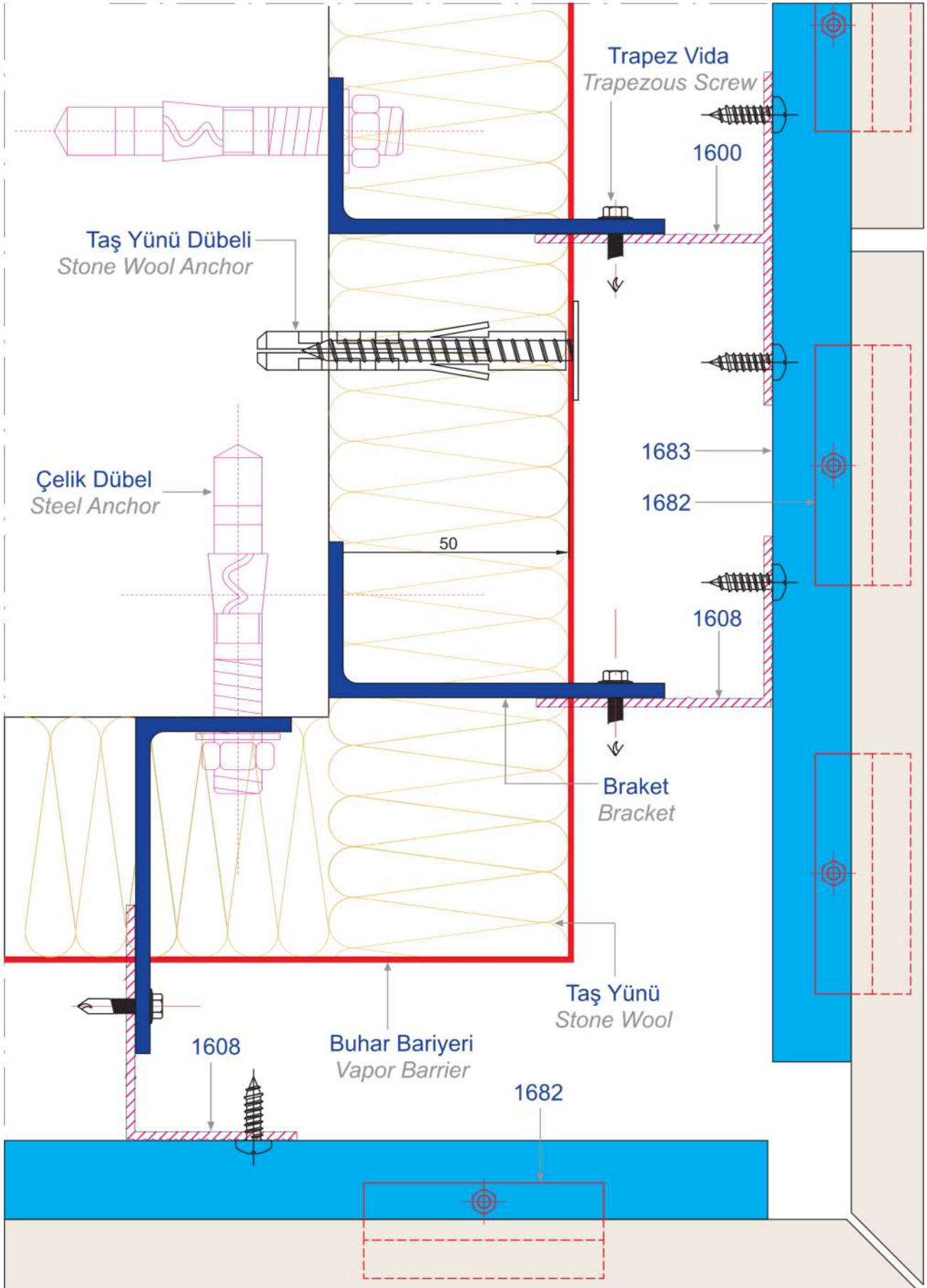

## YARDIMCI MALZEMELER AUXILIARY MATERIALS

Çelik Dübel *Steel Anchor*Taş Yünü *Stone Wool*Trapez Vida *Trapezous Screw*Taş Yünü Dübeli *Stone Wool Anchor*Braket *Bracket*YSB Vida *YSB Screw*Buhar Bariyeri *Vapor Barrier*Ayar Vidası *Adjusting Screw*Fital *Gasket*



## KOMPAKT LAMINANT SİSTEM COMPACT LAMINATE SYSTEM

**ALUREK**  
ALUMINIUM | ARCHITECTURE | BUILDING SYSTEMS

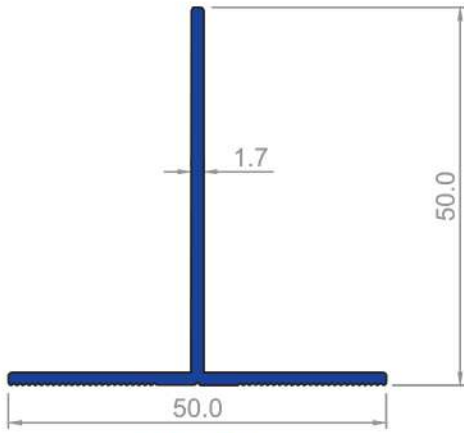

**1621**  
0,439  
Kg/m

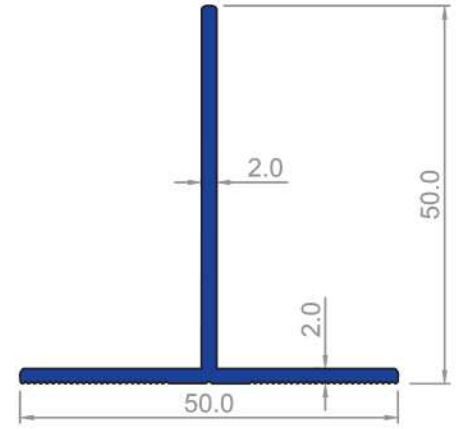

**1622**  
0,518  
Kg/m

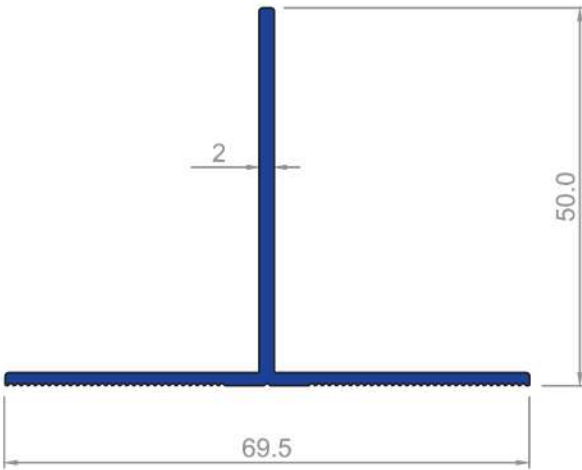

**1626**  
0,618  
Kg/m

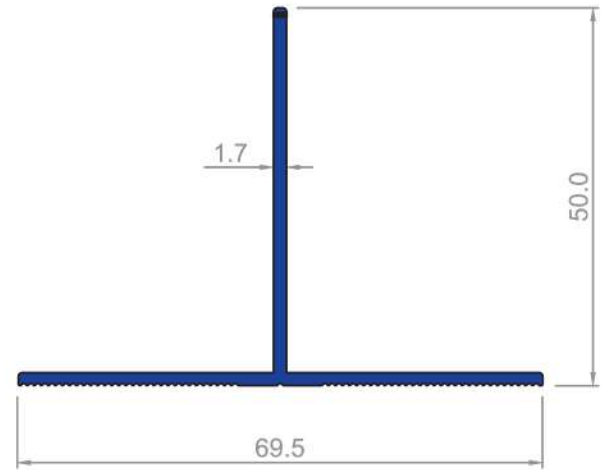

**1600**  
0,523  
Kg/m

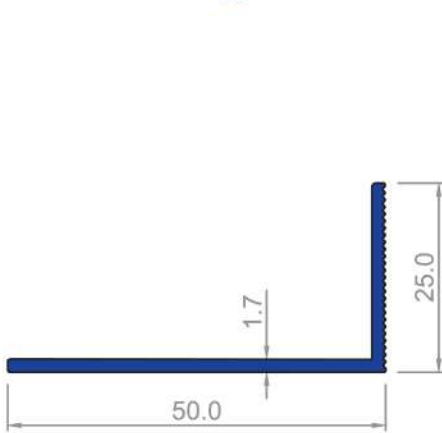

**1608**  
0,328  
Kg/m

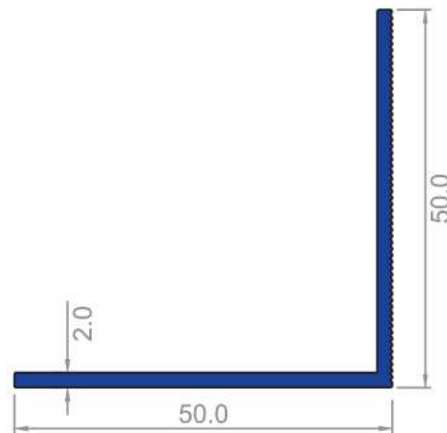

**1641**  
0,516  
Kg/m

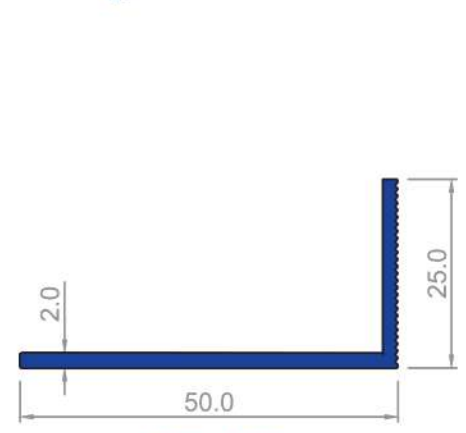

**1642**  
0,388  
Kg/m

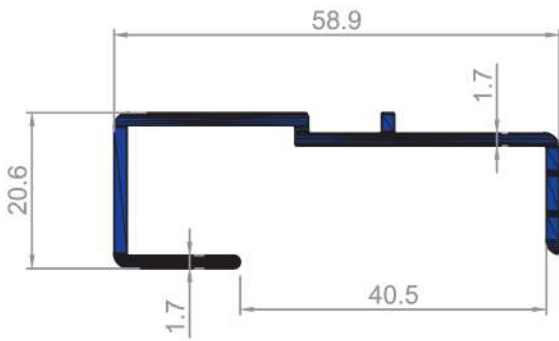
**1681**

0,510  
Kg/m

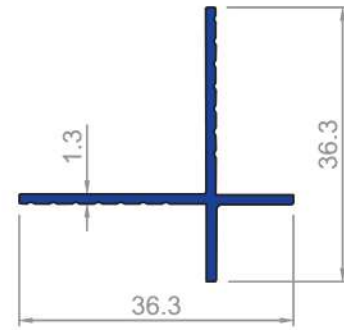
**1643**

0,246  
Kg/m

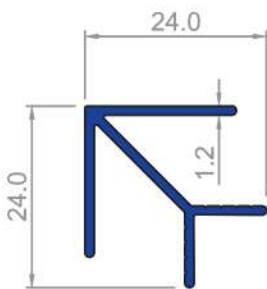
**1613**

0,246  
Kg/m

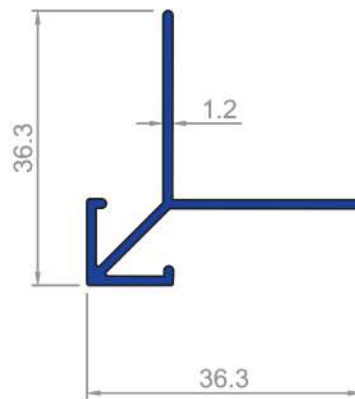
**1610**

0,285  
Kg/m

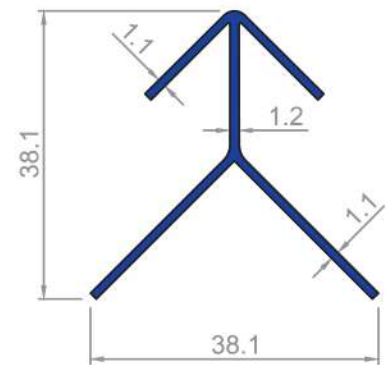
**1644**

0,309  
Kg/m

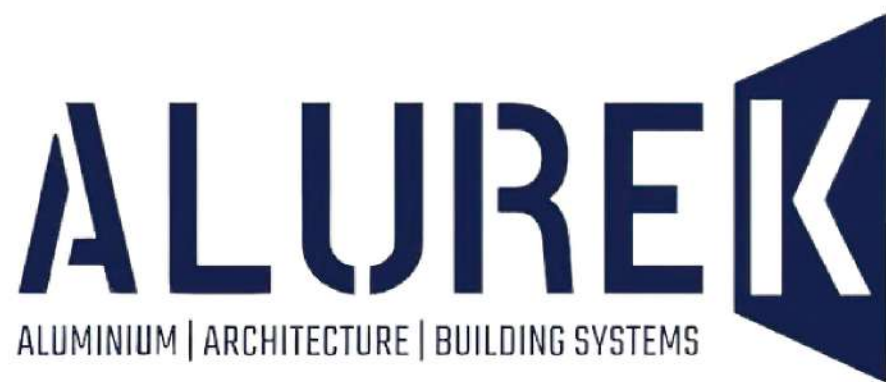



## DETAYLAR DETAILS

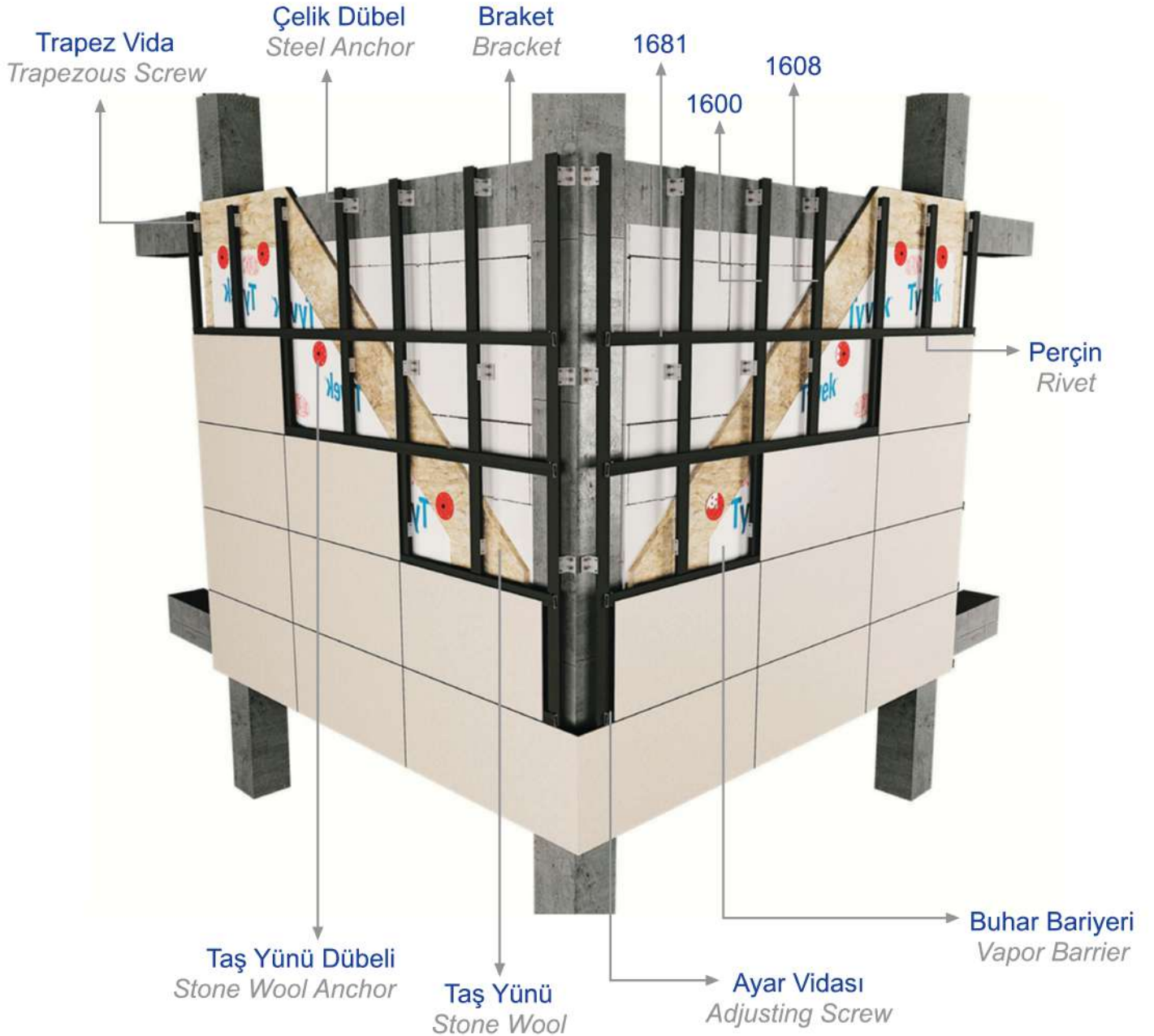



## DETAYLAR DETAILS

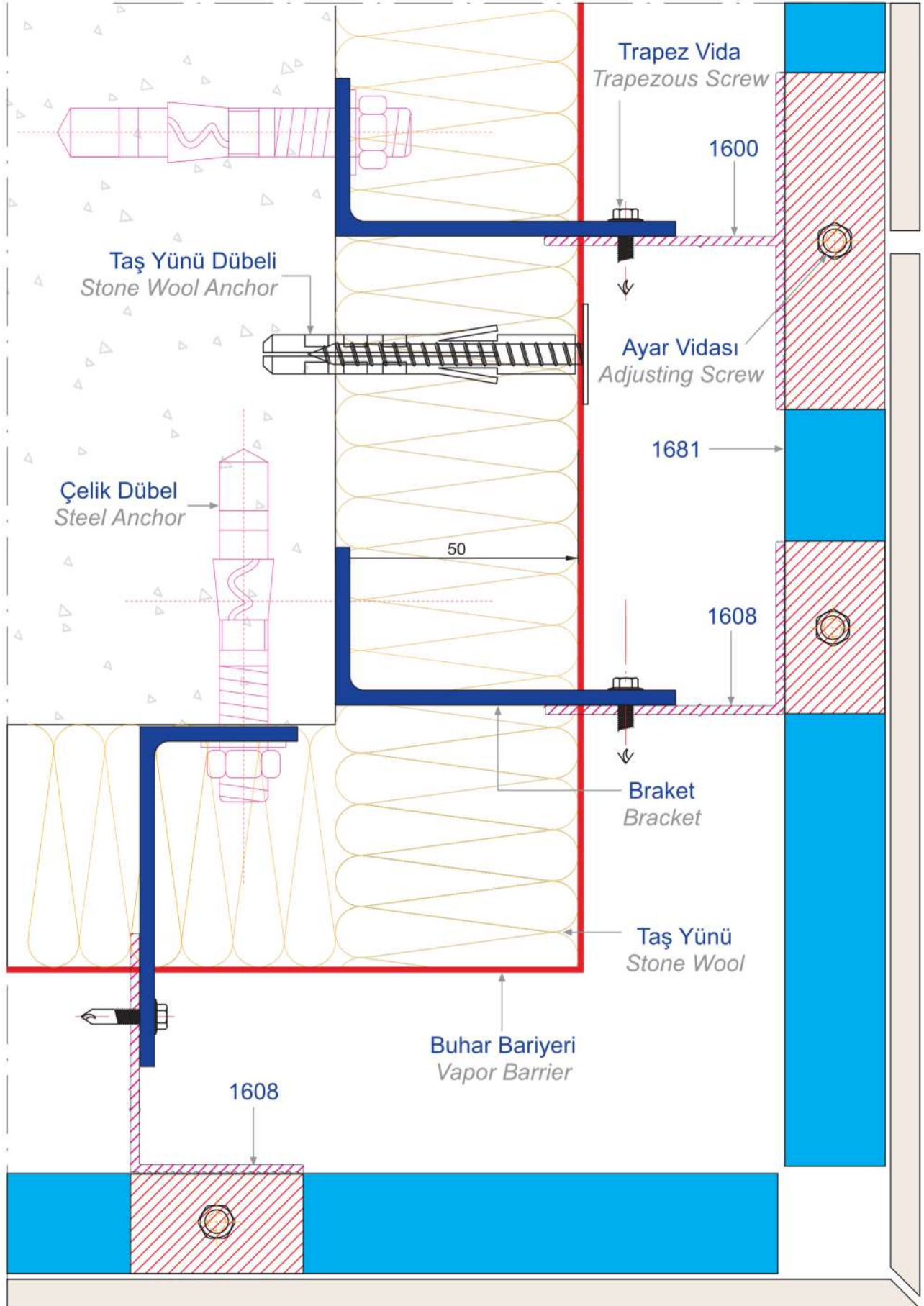

## YARDIMCI MALZEMELER AUXILIARY MATERIALS

Çelik Dübel *Steel Anchor*Taş Yünü *Stone Wool*Trapez Vida *Trapezous Screw*Taş Yünü Dübeli *Stone Wool Anchor*Braket *Bracket*YSB Vida *YSB Screw*Buhar Bariyeri *Vapor Barrier*Ayar Vidası *Adjusting Screw*Perçin *Rivet*



**ASKILI SİSTEM**  
SUSPENDED SYSTEM

**ALUREK**  
ALUMINIUM | ARCHITECTURE | BUILDING SYSTEMS

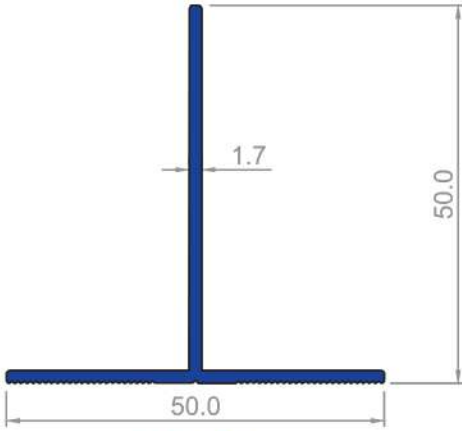

**1621**  
0,439  
Kg/m

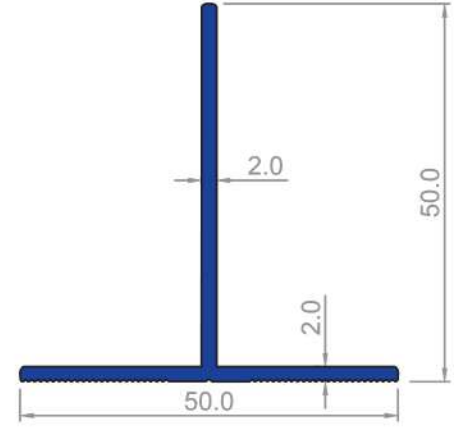

**1622**  
0,518  
Kg/m

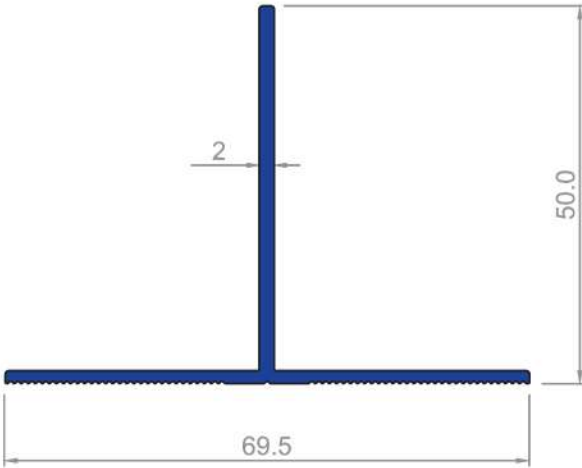

**1626**  
0,618  
Kg/m

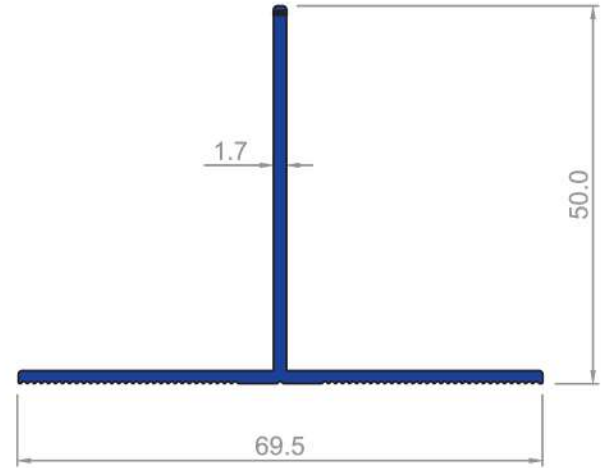

**1600**  
0,523  
Kg/m

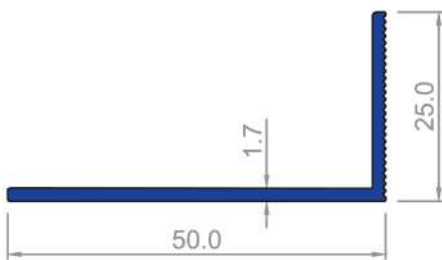

**1608**  
0,328  
Kg/m

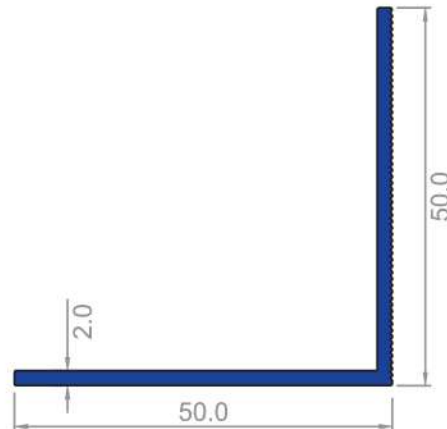

**1641**  
0,516  
Kg/m

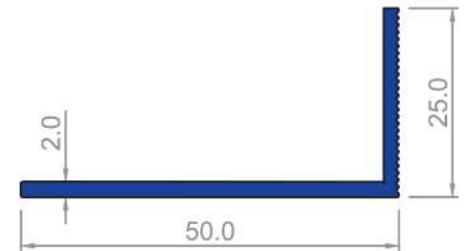

**1642**  
0,388  
Kg/m

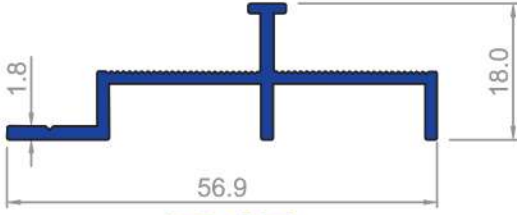

**1645**  
0,566  
Kg/m

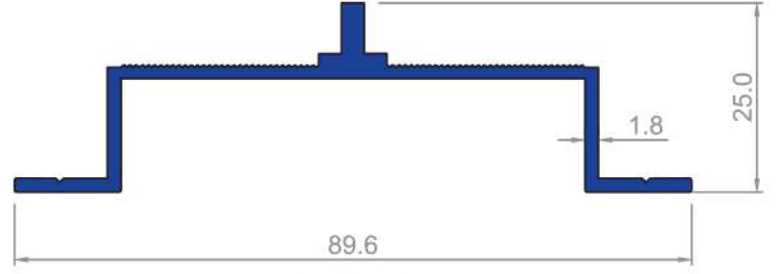

**1638**  
0,653  
Kg/m

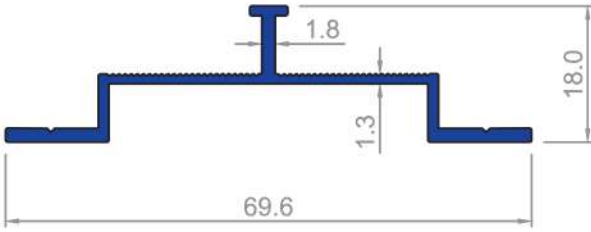

**1625**  
0,378  
Kg/m

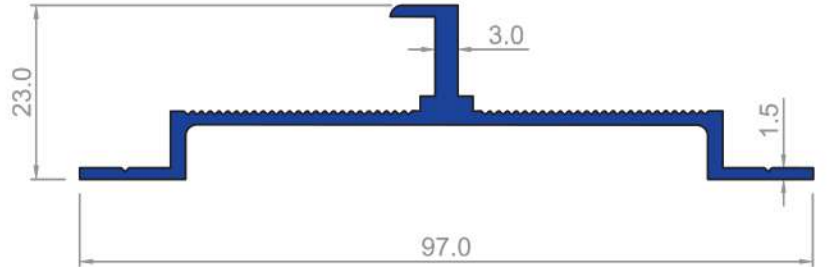

**1629**  
0,658  
Kg/m

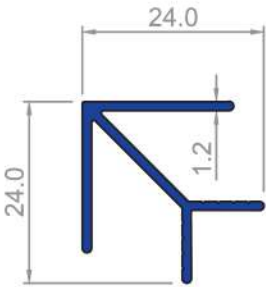

**1613**  
0,246  
Kg/m

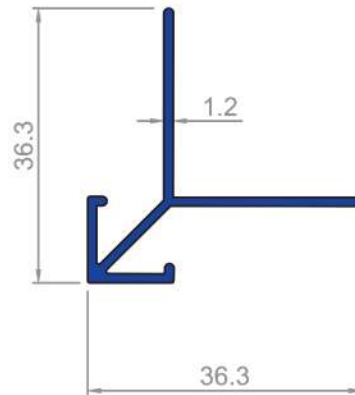

**1610**  
0,285  
Kg/m

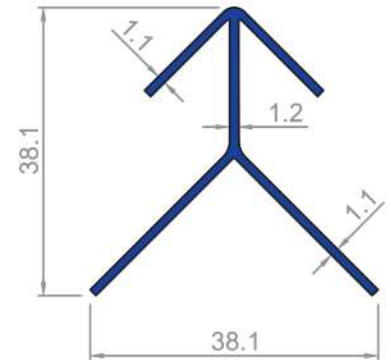

**1644**  
0,309  
Kg/m





## DETAYLAR DETAILS

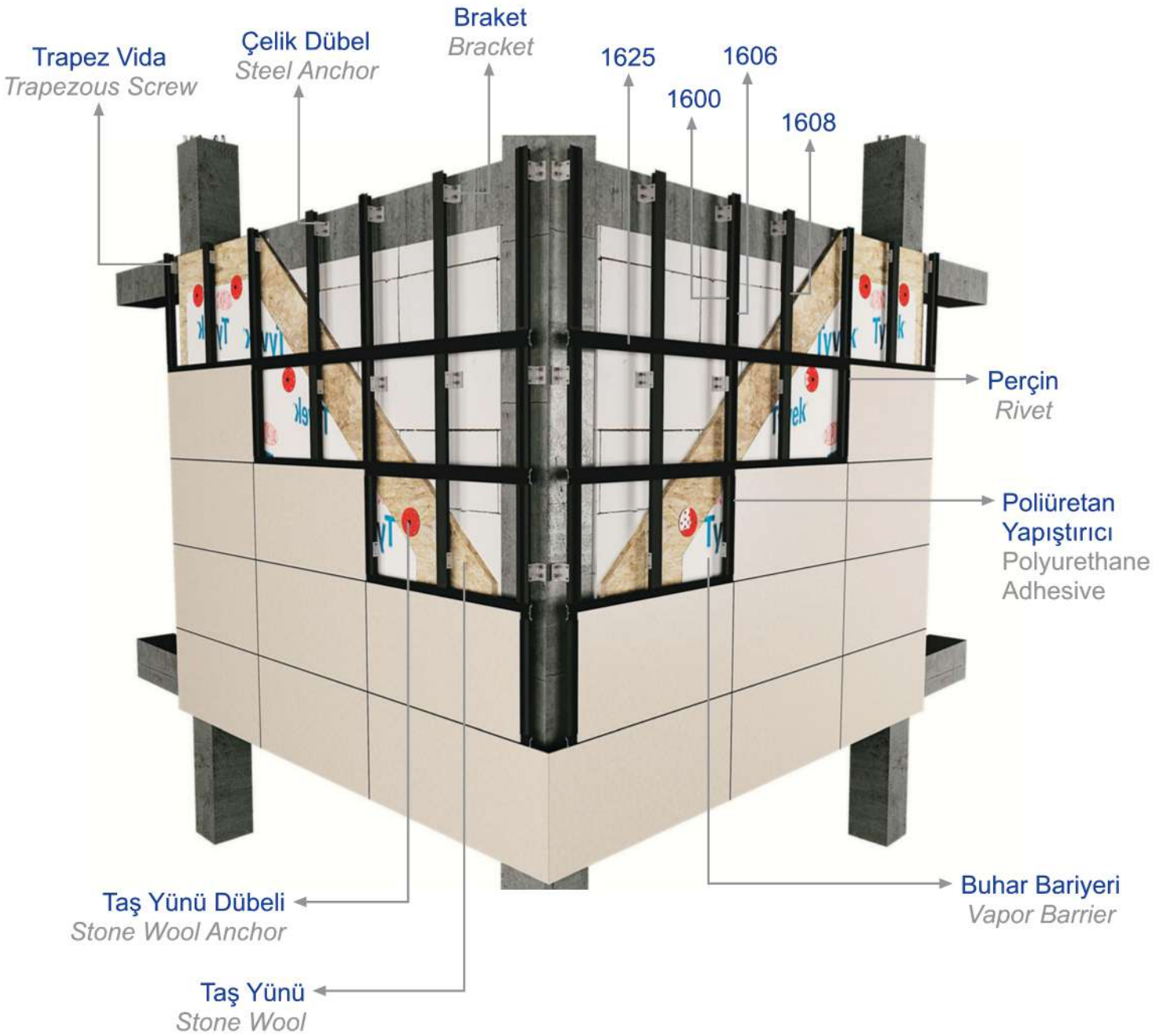
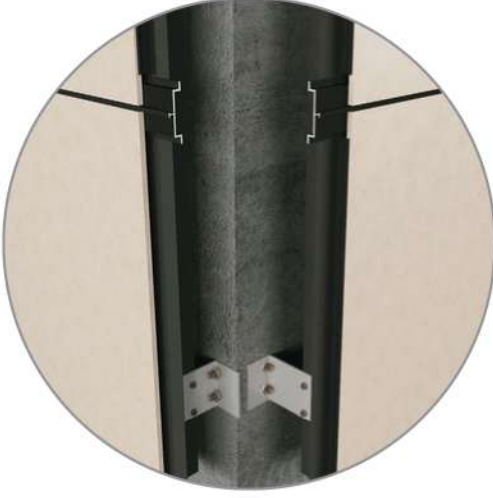

## DETAYLAR DETAILS

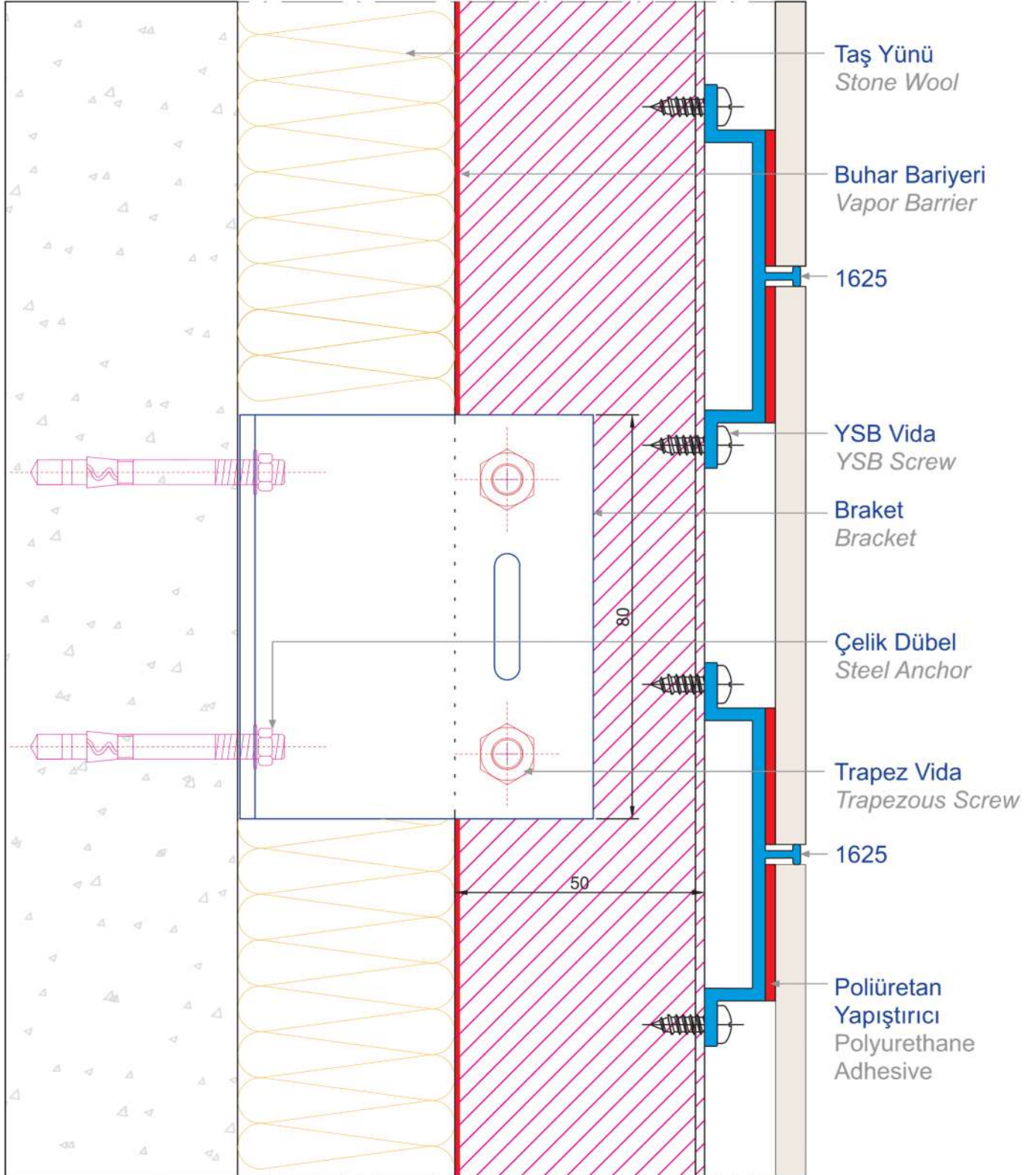

## DETAYLAR DETAILS

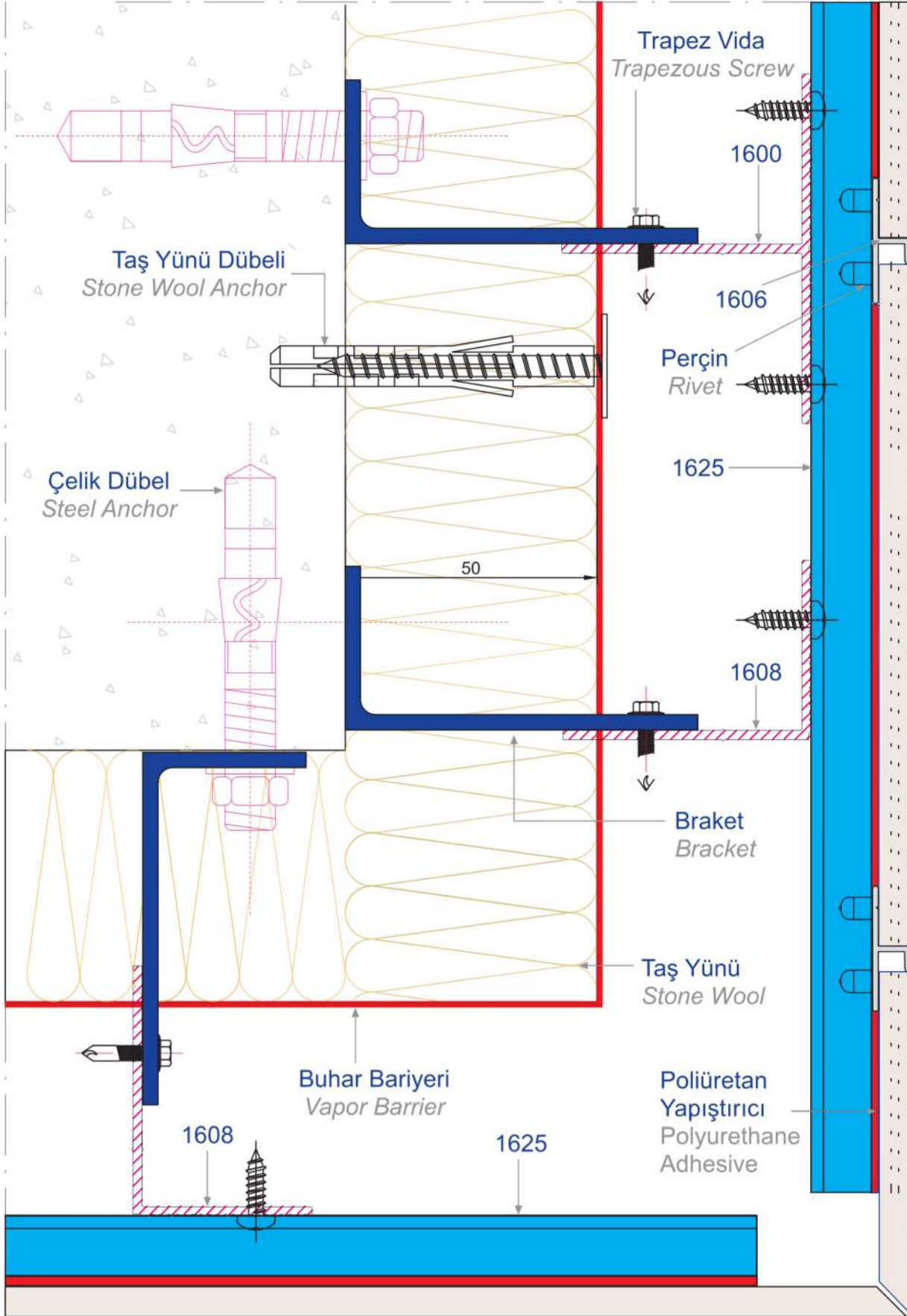

## YARDIMCI MALZEMELER AUXILIARY MATERIALS

Çelik Dübel *Steel Anchor*Taş Yünü *Stone Wool*Trapez Vida *Trapezous Screw*Taş Yünü Dübeli *Stone Wool Anchor*Braket *Bracket*YSB Vida *YSB Screw*Buhar Bariyeri *Vapor Barrier*



**POLİÜRETAN ASKILI SİSTEM**  
POLYURETHANE SUSPENDED SYSTEM

**ALUREK**  
ALUMINIUM | ARCHITECTURE | BUILDING SYSTEMS

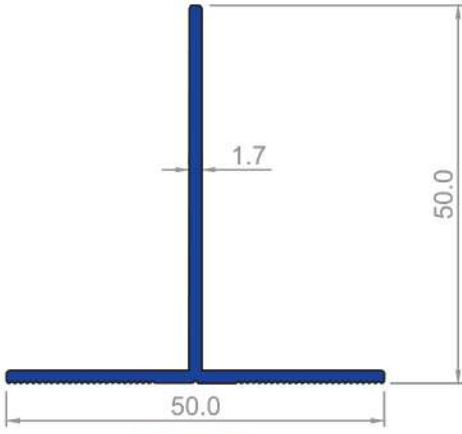

**1621**  
0,439  
Kg/m

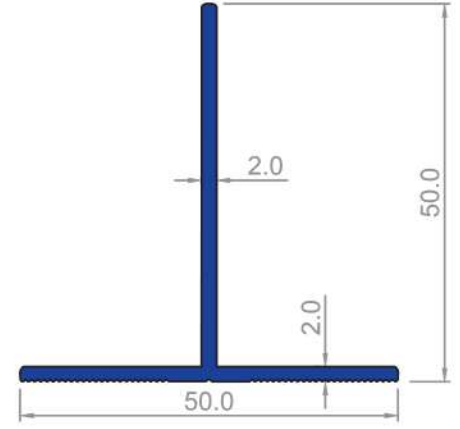

**1622**  
0,518  
Kg/m

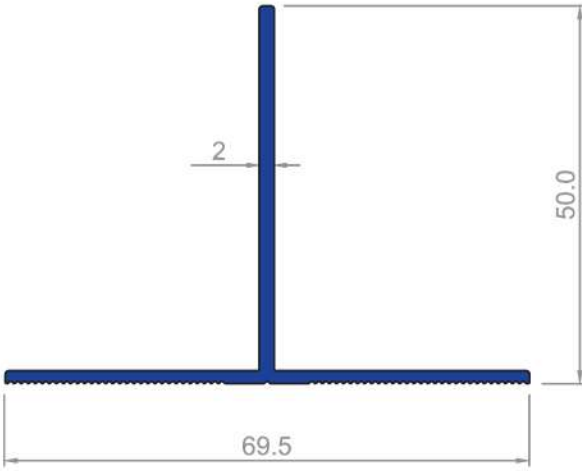

**1626**  
0,618  
Kg/m

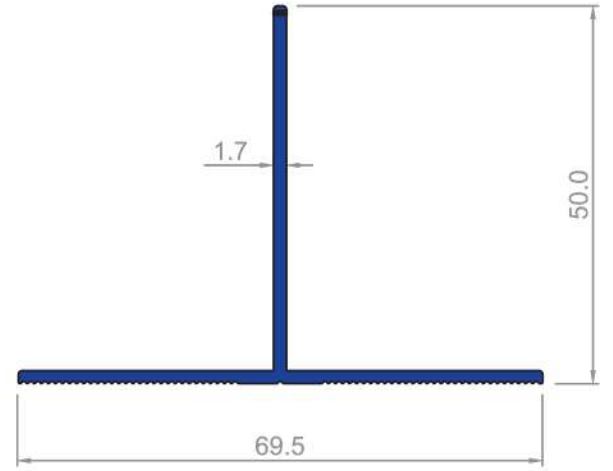

**1600**  
0,523  
Kg/m

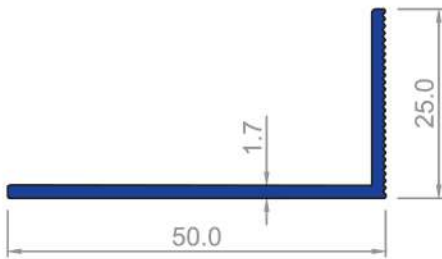

**1608**  
0,328  
Kg/m

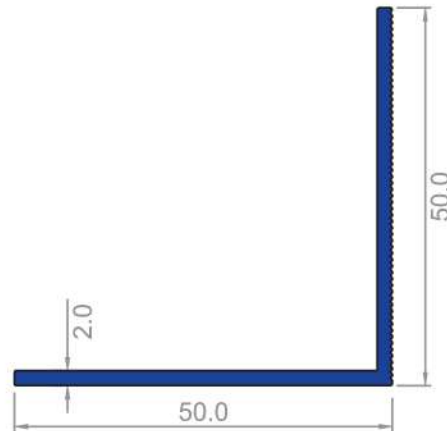

**1641**  
0,516  
Kg/m

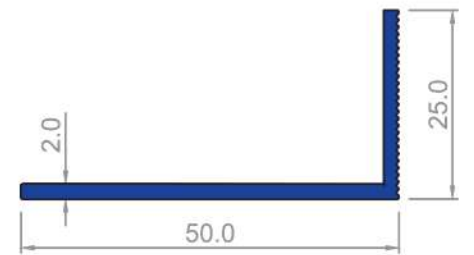

**1642**  
0,388  
Kg/m

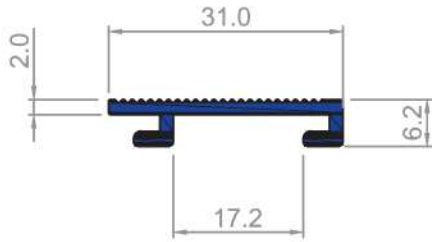

**1685**

0,230  
Kg/m

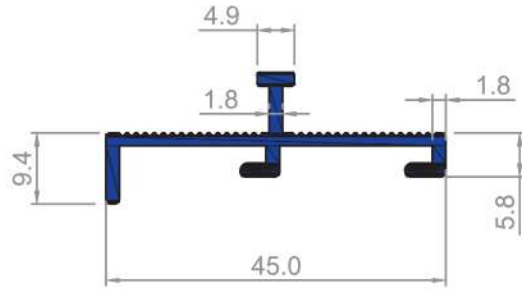

**1686**

0,350  
Kg/m

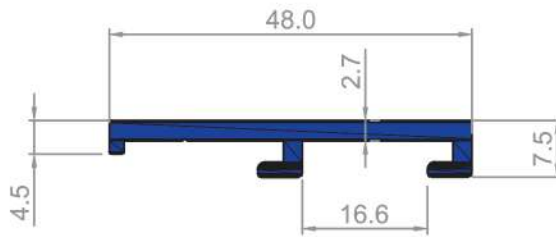

**1689**

0,460  
Kg/m

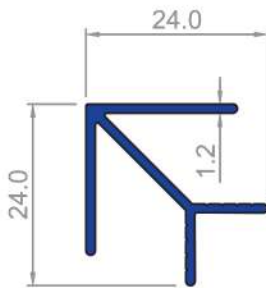

**1613**

0,246  
Kg/m

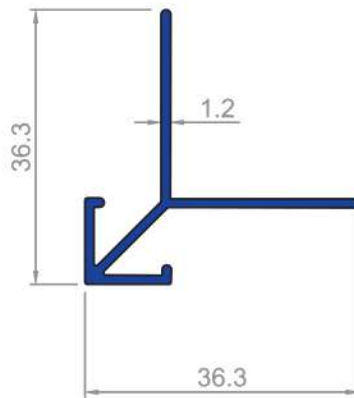

**1610**

0,285  
Kg/m

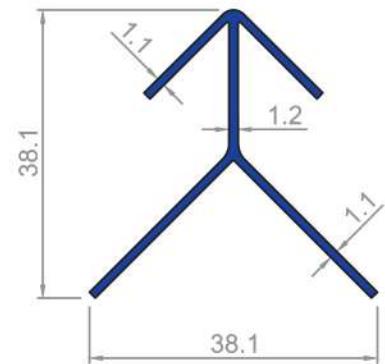

**1644**

0,309  
Kg/m





## DETAYLAR DETAILS

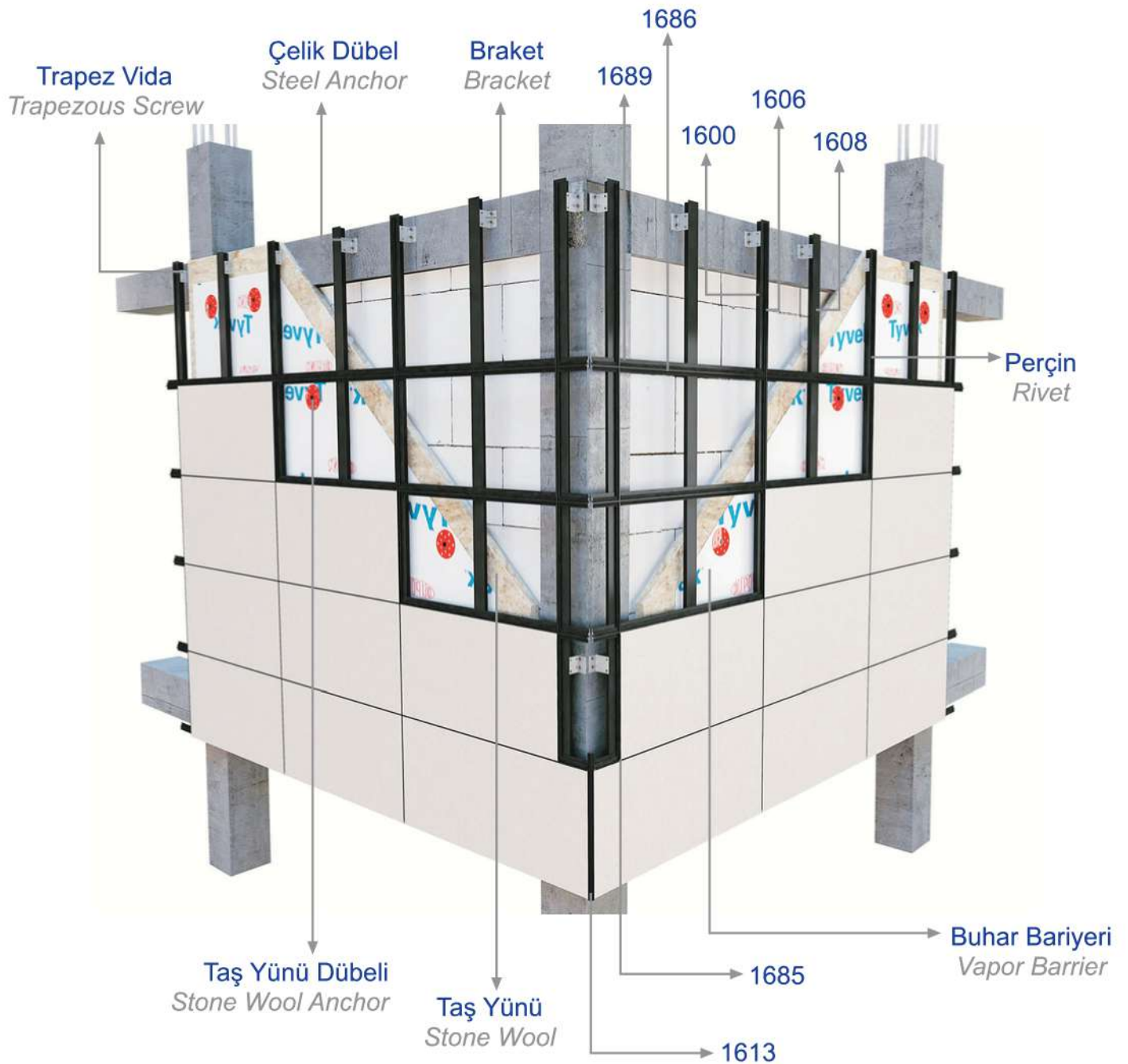
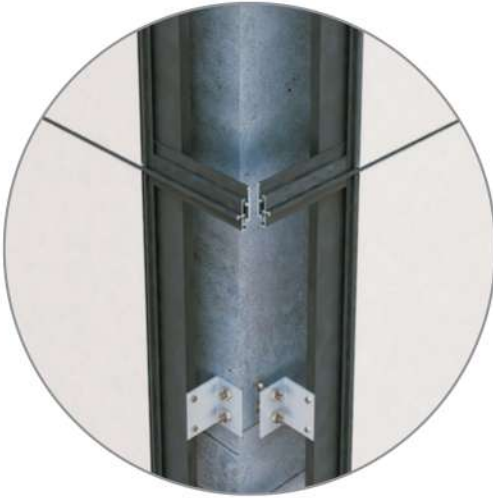

## DETAYLAR DETAILS

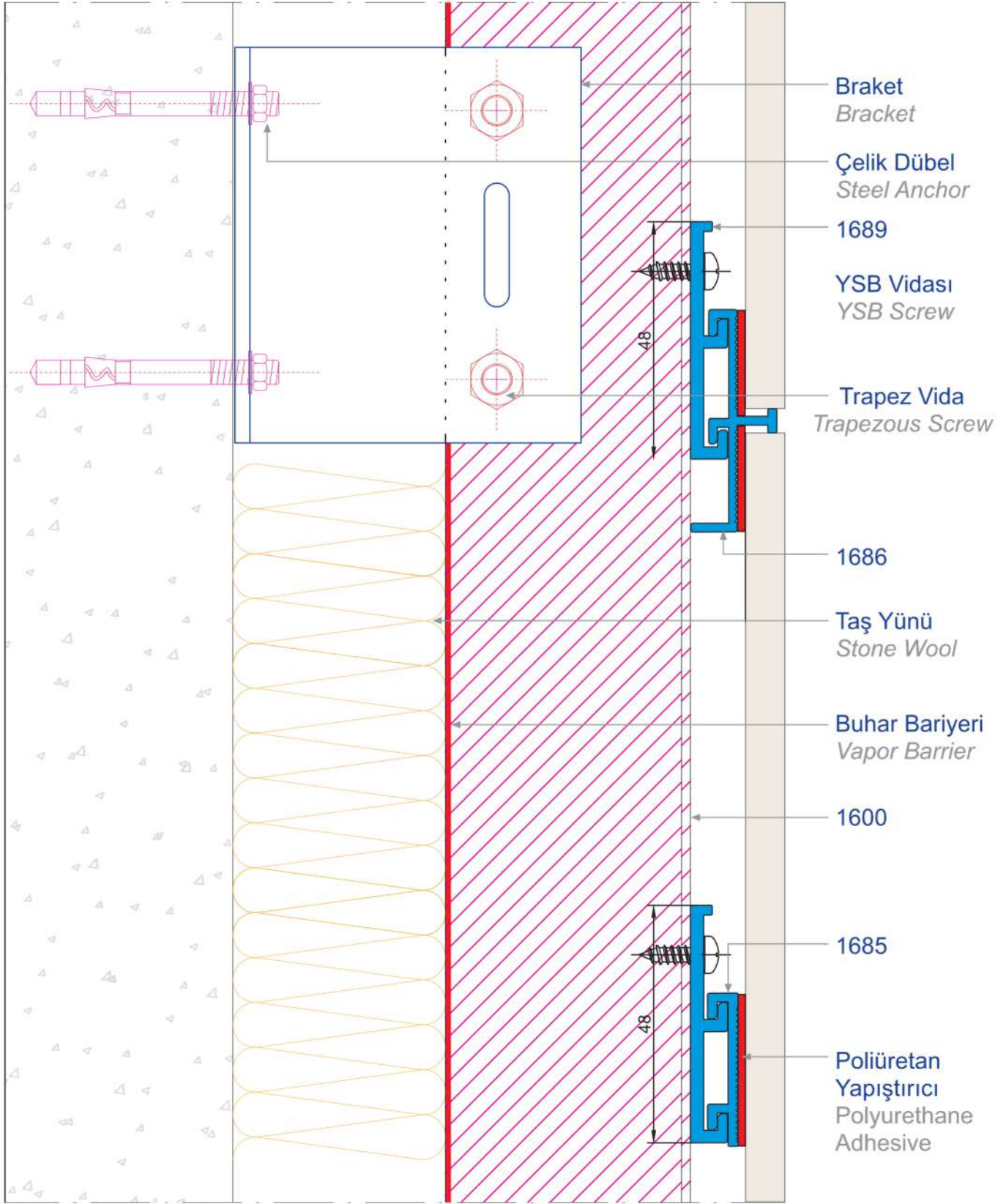

## DETAYLAR DETAILS

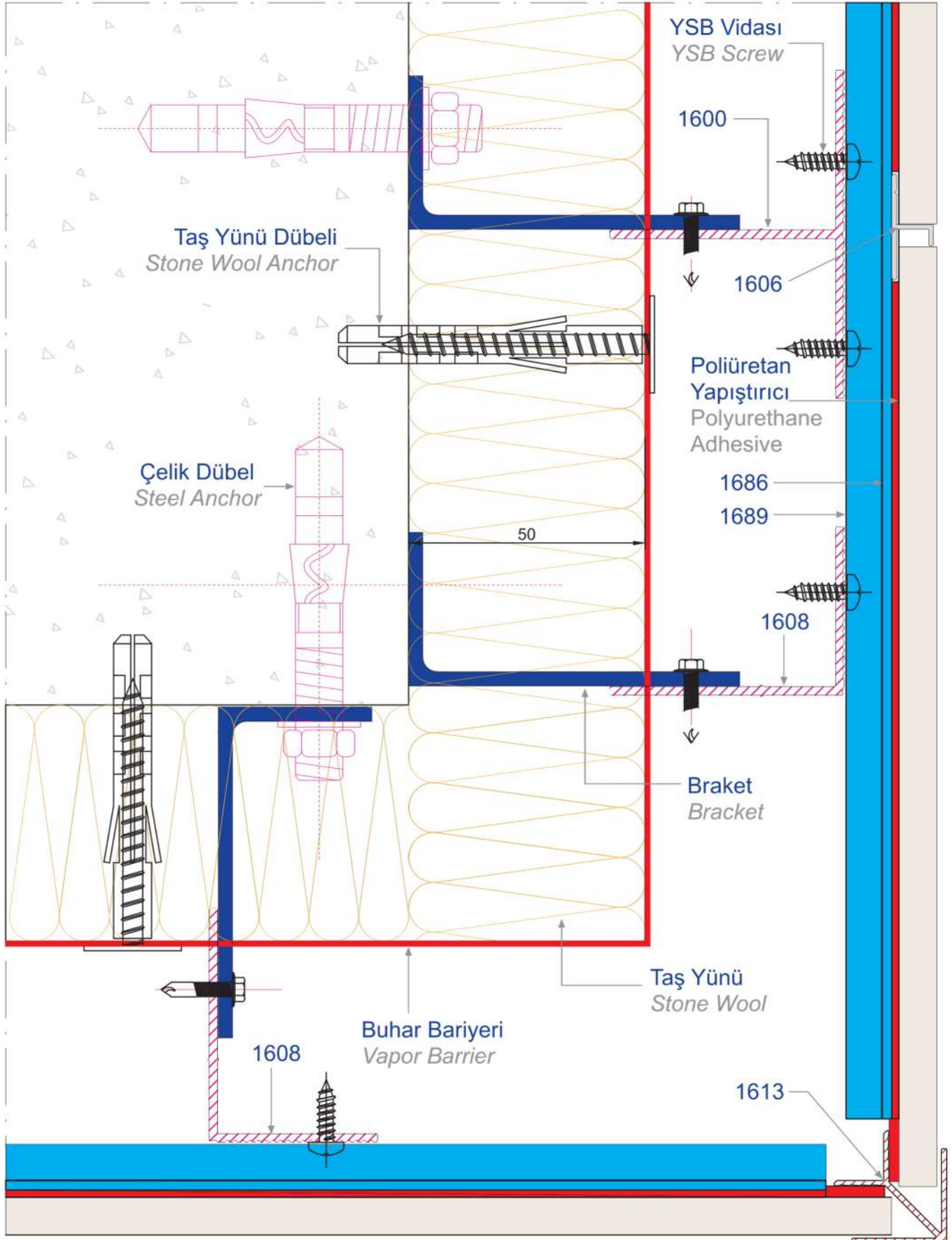

## YARDIMCI MALZEMELER AUXILIARY MATERIALS

Çelik Dübel *Steel Anchor*Taş Yünü *Stone Wool*Trapez Vida *Trapezous Screw*Taş Yünü Dübeli *Stone Wool Anchor*Braket *Bracket*YSB Vida *YSB Screw*Buhar Bariyeri *Vapor Barrier*Soudal 40FC *Soudal 40FC*Perçin *Rivet*



**BRAKET LİSTESİ**  
BRACKET LIST

**ALUREK**  
ALUMINIUM | ARCHITECTURE | BUILDING SYSTEMS

<b>L</b>		<b>A</b>		<b>S</b>
BAYRAK BOYU Cephe Açıklığı (mm)		Braket Yüksekliği (mm)		Kalınlık (mm)
50	X	0-200mm	X	4
60	X	0-200mm	X	4
70	X	0-200mm	X	3,2
80	X	0-200mm	X	3,2
80	X	0-200mm	X	4,0
100	X	0-200mm	X	3,2
100	X	0-200mm	X	4
120	X	0-200mm	X	3,2
120	X	0-200mm	X	4
130	X	0-200mm	X	3,2
150	X	0-200mm	X	3,2
150	X	0-200mm	X	4

**0-80mm Braket Yüksekliğinde Tek Delik ve Tek Slot Kullanılmaktadır**  
(Örnek Çizim Aşağıda Yer Almaktadır)



**80-200mm Braket Yüksekliğinde Çift Delik ve Çift Slot Kullanılmaktadır**  
(Örnek Çizim Aşağıda Yer Almaktadır)

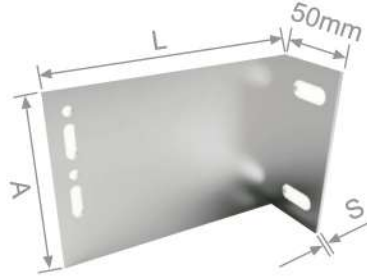



**STANDART PROFİLLER**  
STANDARD PROFILES

**ALUREK**  
ALUMINIUM | ARCHITECTURE | BUILDING SYSTEMS

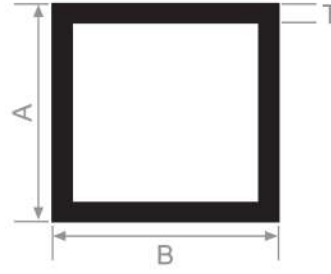

Kutu Profilleri  
Box Profiles

Ürün Kodu	A	B	T	mt/gr
3331	10	10	1,2	0,114
3345-1	14	33	1,3	0,313
3335	15	15	0,9	0,138
3330	17	25	1,5	0,317
3345	17	44	1,3	0,411
3307	20	10	1,5	0,219
3309	20	20	1,5	0,301
3310	20	30	1,5	0,382
3314	20	40	1,2	0,374
3306	20	40	1,5	0,463
3320	20	40	2,0	0,607
3354	20	50	2,0	0,715
3336	20	60	1,2	0,505
3364	20	60	1,5	0,626
3351	20	60	2,0	0,823
3362	20	80	1,0	0,531
3328	20	80	1,2	0,637
3363	20	100	1,0	0,640
3311	25	25	1,5	0,382
3334	25	105	1,5	1,033
3308	30	30	1,5	0,463
3332	30	30	3	0,878
3326	30	40	2	0,715
3346	30	40	3,0	1,100
3348	30	50	2,0	0,823
3347	30	60	1,5	0,707
3339	30	100	1,6	1,100
3340	30	150	1,8	1,720
3313	32	75	1,2	0,680
3304	40	40	1,2	0,504
3305	40	40	1,5	0,626
3324	40	40	2,0	0,822
3324-1	40	40	3,0	1,203
3312	40	50	1,2	0,570
3327	40	50	2	0,932

Ürün Kodu	A	B	T	mt/gr
3325	40	60	1	0,531
3338	40	60	1,5	0,789
3355	40	60	2,0	1,040
3323	40	80	1,4	0,889
3349	40	80	2,0	1,258
3366	40	120	1,6	1,359
3319	47	87	2,0	1,409
3321	50	50	2	1,041
3368	50	50	6	2,861
3316	50	95	1,5	1,155
3315	50	100	1,5	1,195
3337	50	100	2,0	1,583
3356	50	100	3,0	2,341
3317	50	150	1,8	1,915
3341	50	200	2,5	3,320
3365	50	200	4,0	5,246
3352	60	60	2,0	1,257
3353	60	80	1,5	1,114
3322	60	120	1,6	1,533
3370	64	150	12,0	12,357
3329	80	80	1,5	1,276
3369	80	80	3,0	2,504
3371	80	150	12,0	13,398
3319	87	47	2,0	1,409
3357	93	93	2,0	1,973
3367	100	100	1,4	1,496
3318	100	100	1,8	1,915
3358	100	100	3,0	3,155
3359	100	100	4,0	4,163
3342	100	150	2,0	2,667
3343	100	200	3,0	4,781
3360	120	120	2,5	3,180
3344	150	150	3,0	4,780
3372	150	159	12,0	18,536



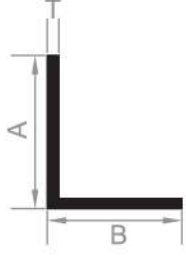

Köşebent Profilleri  
Corner Profiles



Lama Profilleri  
Bar Profiles

Ürün Kodu	A	B	T	mt/gr
3004	20	20	1,5	0,156
3031	20	30	1,2	0,157
3006	20	40	1	0,160
3010	20	50	2	0,369
3024	20	60	1,4	0,298
3025	20	80	1,4	0,374
3026	20	100	1,4	0,450
*1608	25	50	1,7	0,330
*1642	25	50	2,0	0,388
3007	30	30	1	0,160
*3027	30	30	1,8	0,275
3030	30	30	2,0	0,314
3011	30	40	2	0,369
3012	30	50	2	0,423
3005	40	40	1	0,214
3009	40	40	4	0,823
3033	40	50	2	0,477
3032	50	50	1,2	0,321
3019	50	50	2	0,531
*1641	50	50	2	0,516
3008	50	50	4	1,040
3028	50	60	4	1,149
3018	50	70	3,2	1,013
3013	50	80	3,2	1,099
3029	50	80	4,0	1,365
3014	50	100	3,2	1,273
3021	50	100	4	1,582
3015	50	120	3,2	1,446
3022	50	120	4	1,799
3016	50	130	3,2	1,533
3036	50	150	2,0	1,073
3017	50	150	3,2	1,707
3023	50	150	4	2,125
3038	60	60	4	1,257
<b>* OLAN ÜRÜNLER TIRTILLIDIR</b>				

Ürün Kodu	A	B	mt/gr
6032	9,9	16,9	0,452
3804	10	3,0	0,477
3803	10	5	0,195
3802	15	3	0,171
3801	15	5	0,146
3805	40	4	0,647
3806	70	4	0,294
3808	80	4	0,818
556	85	4	0,162
3809	100	5	0,238
3807	130	4,0	0,396

# ALUREK

ALUMINIUM | ARCHITECTURE | BUILDING SYSTEMS

Office : Varlık Mah. 100. Yıl Bulvarı 111/c  
Muratpaşa/Antalya  
Showroom: Çakırlar Mah. No: 118  
Konyaaltı/Antalya

info@alurek.com.tr

Tel: +90 506 946 31 81

www.alurek.com.tr

@alurekturkey